



# GS

CONTRACT  
BOOK

DESIGNS &  
CONTRACT



DANIEL H. ANIDJAR  
CO-OWNER

T. +34 680 67 21 12  
[daniel@designscontract.com](mailto:daniel@designscontract.com)  
[@designscontract](https://www.instagram.com/designscontract)

# The contract book

Furniture  
made  
with love

# GRASSOLER

---

**EN** · Grassoler is a leading Spanish company engaged in the manufacture of contemporary upholstered furniture, 100% made in Spain. Since its establishment in 1960 in Barcelona as a family business, we have been committed to innovation in design and offering the highest quality level in manufacturing our sofas.

Grassoler is located in Barcelona, where our facilities cover an overall area of 8.000 m<sup>2</sup> (86,000 sq.ft.) for offices and production with another 700 m<sup>2</sup> (7,500 sq.ft.) of showroom space.

The range of products offered includes contract, hospitality and residential. We have been exporting all over the world for over 40 years.

**ES** · La empresa Grassoler es una de las primeras firmas españolas, y la más antigua, dedicada en exclusiva al mueble tapizado, fabricado íntegramente en España. Desde su creación en 1960 en Barcelona como empresa familiar apostamos por la innovación en el diseño y por la más alta calidad en la fabricación a la hora de producir nuestros sofás.

Situada en las afueras de Barcelona, nuestras diversas instalaciones actuales disponen de una superficie global de aproximadamente 8.000 m<sup>2</sup> destinadas a oficinas y producción y un showroom de 700 m<sup>2</sup>.

La gama de productos abarca desde la instalación para todo tipo de colectividades hasta el canal hogar. Grassoler opera desde hace más de 40 años exportando a todo el mundo.

Special thanks to:  
Diseño gráfico:  
Cèl·lula

Estilismo y dirección de arte:  
Patricia Gras

Fotografía:  
Starp Estudi  
Albert Font  
Hausmann Fotografía  
Martin y Zentol  
Carme Macià

Edición:  
Noviembre 2022

© de la edición, Grassoler, 2022  
Calle La Clota, 22 - 08290  
Cerdanyola del Vallès  
Barcelona



# INDEX

introduction.....11	Products	Madalena..... 290
Hotels..... 35	Artemis.....170	Mad Bureau · Mad Home.....292
Corporate Offices..... 57	Berlin.....174	Nicolay..... 296
Restaurants..... 75	Berna · Berna Madera.....178	Nicolay Calma.....300
Airport Lounges.....89	Bon Bon.....180	Nicolay Esencial.....304
Healthcare.....107	Boy.....182	Odin Fun..... 306
Financial.....119	Cala d'Or.....186	OdysseyFun..... 310
Public Areas.....129	Calas.....188	Onix.....314
Sports Clubs.....147	Cayman.....190	Opal.....316
Institutional.....154	Charme · Charme Mix.....194	Opalina.....318
Educational.....154	Clip.....198	Open Air.....322
Luxury Residential.....154	Cubic.....200	Open Air Vintage.....324
Customized.....156	Cuc.....204	Oracle..... 326
	Dakota.....208	Oxygen..... 328
	Daris.....212	Parade.....330
	Deep 87.....216	Parcel.....332
	Definy.....218	Pasarela.....334
	Durban.....223	Patek.....336
	Elder.....224	Pipa.....338
	Elder Vintage.....228	Riverso.....340
	Eudos · Eudos Pastillas.....230	Rosetta.....344
	Euphoria XXI.....234	Seneca.....348
	Every.....240	Tong.....350
	Every Madera.....244	Topic.....354
	Evolve.....246	Traffic · Transit.....356
	Finca Mini.....248	Wasabi.....362
	Fiord.....250	
	Glamour.....252	
	Global.....256	
	Grammy.....258	
	Hexa · Mesa Hexa.....260	
	Hiru · Hirusta.....264	
	Inbol.....266	
	Interval.....268	
	Intruder.....272	
	Invader.....274	
	Jack.....276	
	Kanel · Kanel Fluffy.....278	
	Koly Fija · Koly Vel.....282	
	Lavanda · Mentá · Salvia.....284	
	Loop.....286	

# INDEX



Artemis · 170



Berlin · 174



Berna · Berna Madera · 176



Bon Bon · 180



Fiord · 250



Glamour · 252



Global · 256



Grammy · 258



Boy · 182



Cala d'or · Calas · 186



Cayman · 190



Charme · 194



Hexa · Mesa Hexa · 260



Hiru · Hirusta · 264



Inbol · 266



Interval · 268



Clip · 198



Cubic · 200



Cuc · 204



Dakota · 208



Intruder · 272



Invader · 274



Jack · 276



Kanel · Kanel Fluffy · 278



Daris · 212



Deep 87 · 216



Definy · 218



Durban · 222



Koly Fija · Koly Vel · 282



Lavanda · Menta · Salvia · 284



Loop · 286



Madalena · 290



Elder · 224



Elder Vintage · 228



Eudos · Eudos Pastillas · 230



Euphoria XXI · 234



Mad Bureau · Mad Home · 292



Nicolay · 296



Nicolay Calma · 300



Nicolay Esencial · 304



Every · 240



Every Madera · 244



Evolve · 246



Finca mini · 248



Odin Fun · 306



Odyssey Fun · 310



Onix · 314



Opal · 316



Opalina · 318



Open Air · 322



Open Air Vintage · 324



Oracle · 326



Oxygen · 328



Parade · 330



Parcel · 332



Pasarela · 334



Patek · 336



Pipa · 338



Riverso · 340



Rossetta · 344



Seneca · 348



Tong · 350



Topic · 354



Traffic · Transit · 356



Wasabi · 362

## ESTABLISHED IN 1960 IN BARCELONA DESDE 1960 EN BARCELONA

---

**EN** · In 1960, at the young age of 19, Jose Gras Soler established Grassoler in a small building in the center of Barcelona. A few years later, the company moved to its current location. 1964 was a banner year for Grassoler when the patented "Intelligent System®" was introduced in the market. This revolutionary modular metal frame spring system developed by Jose Gras launched Grassoler into becoming an industry leader in Spain and later throughout Europe and the rest of the world. It is well established and acknowledged as a culmination of excellence in design and ergonomics in achieving the highest level of performance and comfort, with built-in flexibility unique to the Grassoler brand.

**ES** · Fruto de la iniciativa de José Gras Soler, con 19 años, Grassoler, S.A. nació en 1960 como una pequeña estructura empresarial en un local del centro de Barcelona, que más tarde, en 1966 trasladó a las instalaciones actuales. El negocio empezó a crecer hacia 1964, año de lanzamiento del mayor éxito de ventas que ha tenido la empresa llamado Davis y que la catapultó en España gracias al revolucionario sistema de muelles y armazón de hierro que incorporaba, desarrollado por José Gras y patentado por Grassoler, llamado Intelligent System®, considerado un diseño que incorporaba gran ingeniería constructiva. Ha sido la culminación del binomio diseño y ergonomía que consigue el máximo descanso. Todo ello hace de un Grassoler una pieza muy especial y única.





## TRADITION ALLIED WITH TECHNICS TRADICIÓN ALIADA A LA TÉCNICA

---

**EN** · From the beginning, our philosophy has always been the search for technological innovation and advances beautifully blended with the traditional processes of handcrafted furniture.

**ES** · Durante 63 años nuestra filosofía siempre ha sido la permanente búsqueda de avances técnicos en los materiales y en los procesos de fabricación fusionándolos con los métodos tradicionales y artesanos de fabricación.





## STEEL FRAME STRUCTURE ESTRUCTURAS METÁLICAS

**EN** · Since the mid 1960's, Grassoler has been manufacturing the inside structure of our sofas with metal frames, which were developed and patented under the trade name Intelligent System®. The laminated steel provides our sofa frame structures with very high level of strength and unsurpassed durability. It makes them unique pieces, almost indestructible so that they can be enjoyed for many more years than traditional wooden frames.

**ES** · En Grassoler llevamos fabricando los interiores de los sofás en acero desde 1964, año en el que desarrollamos y patentamos nuestro exclusivo sistema Intelligent System®. El acero por sí mismo, además de dar gran solidez y durabilidad a los sofás, los convierten en piezas únicas. Únicas, indeformables y resistentes al paso de los años.

## 25 YEAR WARRANTY 25 AÑOS DE GARANTÍA

**EN** · Our sofas have level 5 (maximum level) UNE 11020 part 2 and UNE EN 1022-98 corresponding to severe public use. This is equivalent to a test of more than 200.000 drop cycles of 95 kg (210 lbs.) weight. As a result of the excellent material quality, we offer a 25 year warranty of the steel structure, absolutely exceptional in this market sector.

**ES** · Nuestros productos superan el nivel 5 (nivel máximo) de la norma UNE 11020 parte 2 y UNE EN 1022-98 correspondiente a uso público severo. Entre otras pruebas, equivale a más de 200.000 sentadas con un peso de 95 kg. Como resultado de esta excelente calidad, ofrecemos una garantía de 25 años por fabricación en aquellos modelos dotados de estructuras metálicas, algo absolutamente único.



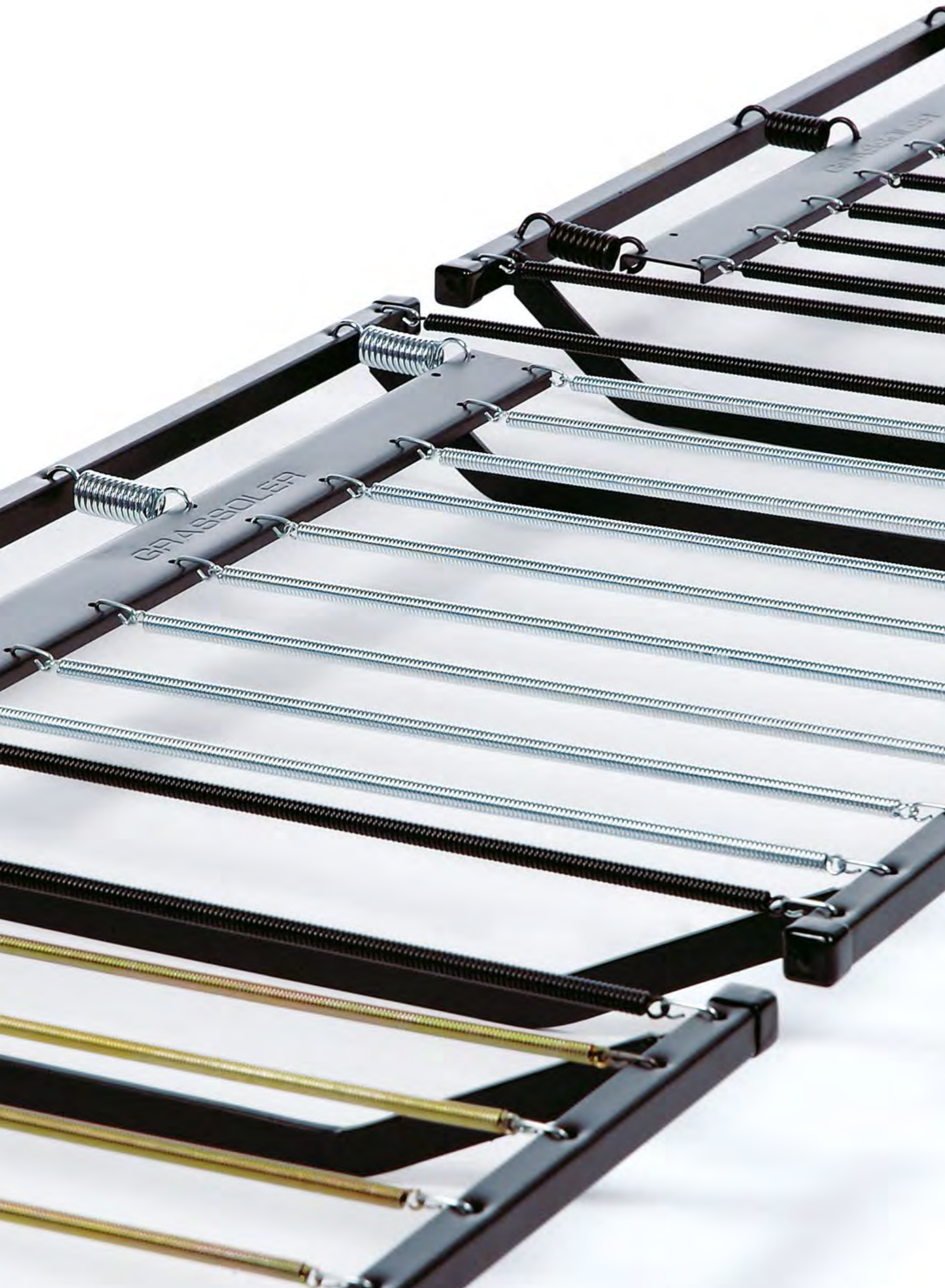

## “TAILOR MADE SUSPENSION” “SUSPENSIÓN A LA CARTA”

**EN** · The Intelligent System® suspension is a system developed and patented by Grassoler almost 60 years. It provides you with a “customized suspension system” meaning that you can personalize the level of firmness in the seat to your own desire. There are three different firmness options: soft, middle and firm.

**ES** · La suspensión Intelligent System® es un sistema desarrollado y patentado por Grassoler hace casi 60 años. Se trata de la “suspensión a la carta” que permite personalizar y adaptar la sentada eligiendo el confort individual en cada sofá, consiguiendo una mayor comodidad. Existen tres opciones posibles: suave, media o firme.



## EASE OF DISASSEMBLY

### TOTALMENTE DESMONTABLE

**EN** · You can easily assemble or disassemble the sofa seats, arms and legs without tools. By simply unscrewing the knobs with your hands and reach through the zippers in the back frame, you will find the knobs that hold the structure together.

**ES** · A través de unas cremalleras y palomillas en la estructura, permite montar y desmontar los módulos, los brazos y pies sin necesidad de herramientas en sencillos pasos.

## REMOVABLE UPHOLSTERY COVERS

### TOTALMENTE DESENFUNDABLE

**EN** · Our sofa covers are easily removable with a system of zippers and velcro that split the covers of the sofa into several parts. The covers can then be washed in a washing machine or taken to the dry cleaner in case the upholstery material requires dry cleaning.

**ES** · Nuestros sofás son fácilmente desenfundables mediante cremalleras y velcros que dividen las fundas del sofá en varias partes para lavar cómodamente en la lavadora doméstica o llevar a la tintorería en el caso de que así lo requiera la tapicería elegida.



## REPLACEABLE UPHOLSTERY PARTS RECAMBIOS DE PIEZAS

**EN** · This system allows you to individually replace part of the sofa that could have been damaged after use, for example: you can replace the arm or just the cover of the arm, depending if the damage is on the fabric or on the structure of the arm.

**ES** · Este sistema permite reemplazar individualmente partes que con el uso hayan podido ser dañadas, por ejemplo: se puede reponer el brazo o sólo la funda del brazo dependiendo si el daño está en la tela o en la estructura del brazo.

## WE MAKE IT EASY TO SPECIFY TE HACEMOS FÁCIL LA ESPECIFICACIÓN

**EN** · We put at your disposal all the **2D and 3D** blocks to use in your own projects.

**ES** · Ponemos a tu disposición todos los bloques 2D y 3D de nuestros muebles para que los utilices en tus propios proyectos.

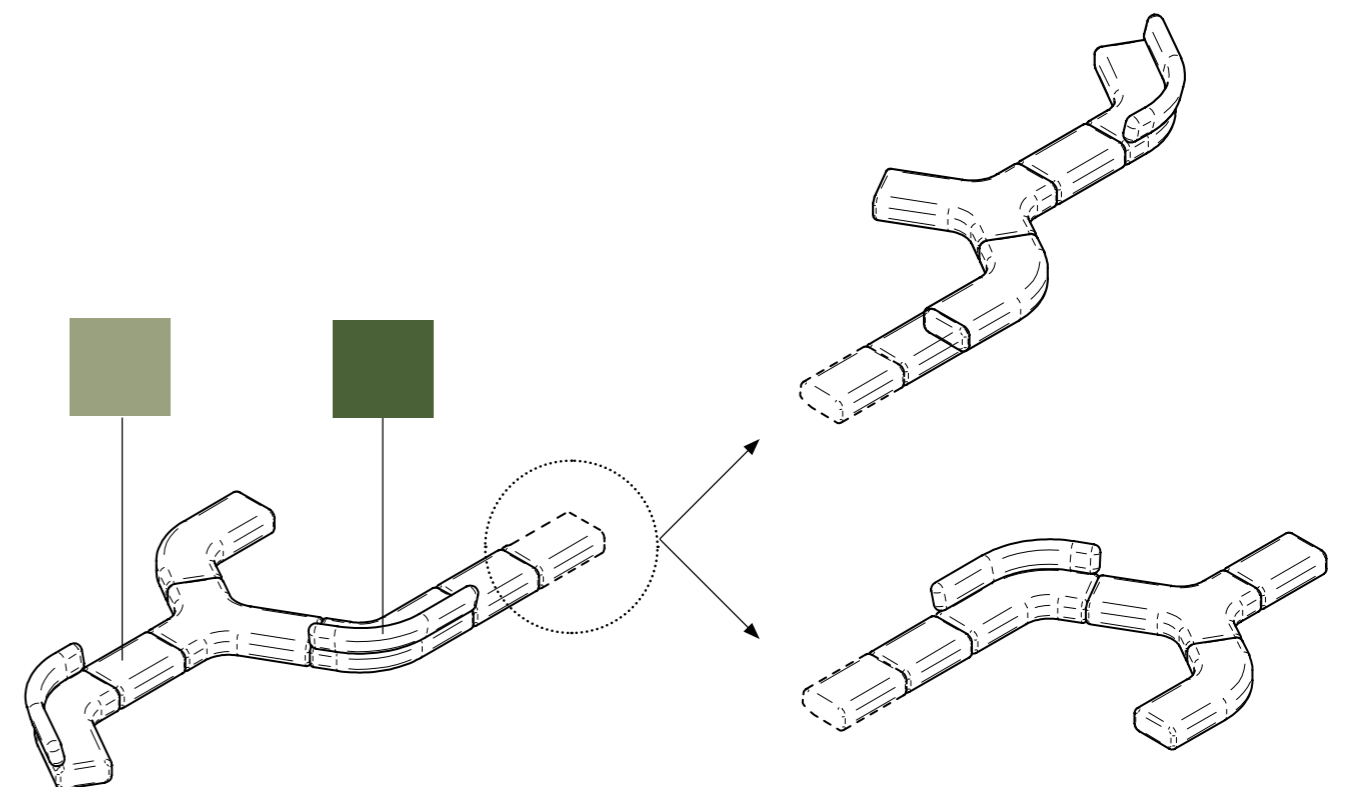
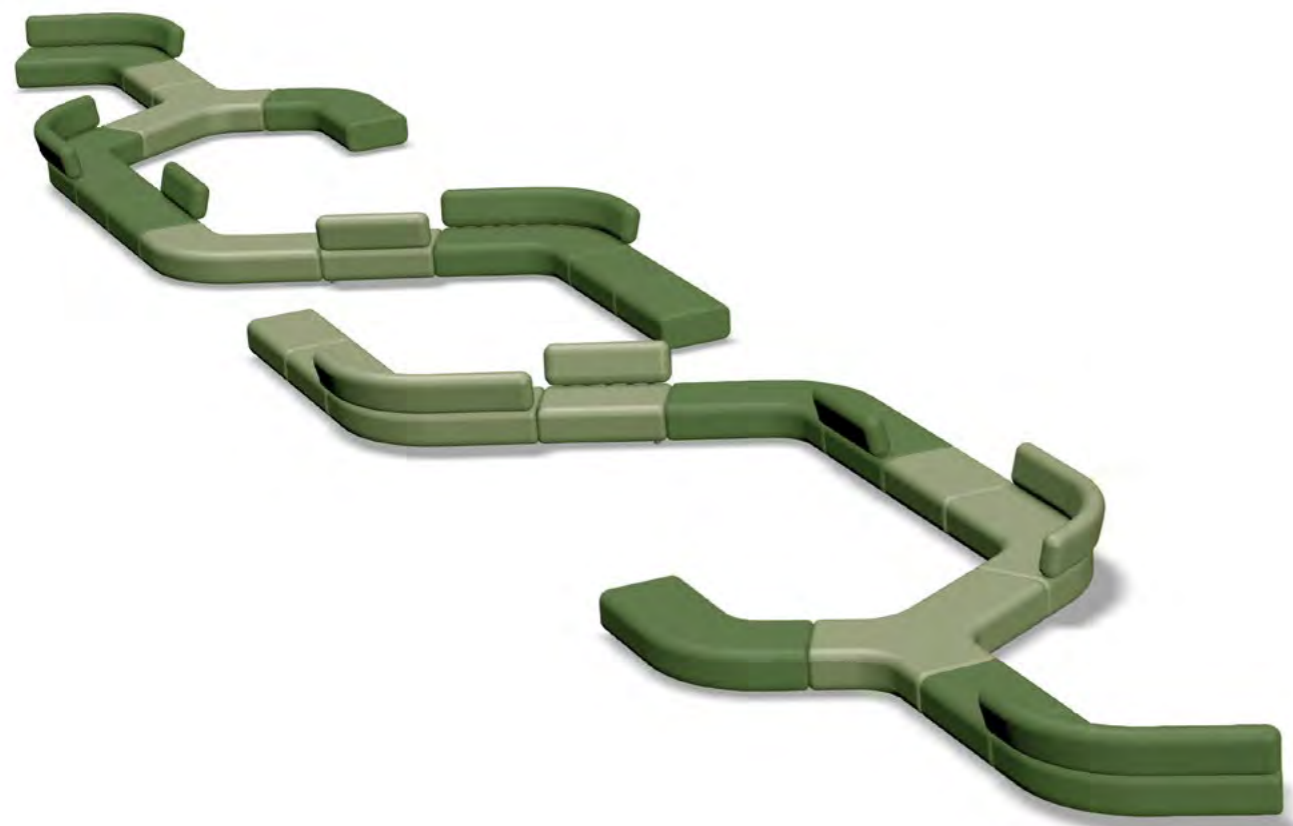



## WE ARE READY TO CREATE YOUR LAYOUTS ESTAMOS LISTOS PARA DISEÑAR TUS LAYOUTS

**EN** · We will help to plan the space with our models, giving you different solutions in order to create a unique project and thus make it easier to take decisions. We will propose different layouts and sketches for the same area. Thanks to our vast experience, we can recommend the kind of sofa and the fabrics that are more suitable.

**ES** · Podemos ayudarte a diseñar tu espacio con nuestros muebles, te plantearemos soluciones diferentes para crear un proyecto singular y único y facilitarte así la toma de decisiones. Propondremos varios layouts y distribuciones dentro de la misma área. Gracias a nuestra extensa experiencia podemos recomendarte qué tipo de sofás y telas son los más adecuados para tu proyecto.

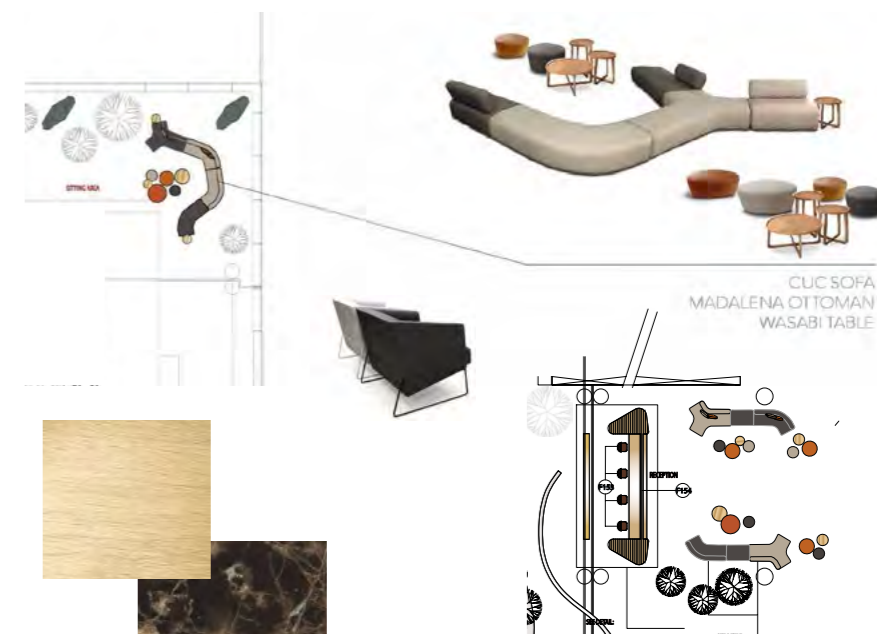



## FLEXIBLE SOLUTIONS SOLUCIONES FLEXIBLES

**EN** · Our design team will support you developing small variations on our standard models, in order to fit your idea and make a sofa that is like no other one.

**ES** · Nuestro equipo de diseño puede darte soporte desarrollando sutiles variaciones en nuestros modelos de colección, de forma que se adapte a tu idea y no haya otro sofá igual.







## WE HELP YOU GIVING BIRTH TO YOUR IDEAS, WE CUSTOMIZE FOR YOU DAMOS VIDA A TUS IDEAS, PODEMOS PERSONALIZAR PARA TI

**EN** · Have you ever had an idea of the perfect sofa that matches your decoration proposals but that it only exists in your head? We give birth to your idea creating a unique model for yourself. We can provide you with solutions for projects with our experience in loose furniture design to develop customized designs. We are able to adapt to the project specifications to meet local regulations.

**ES** · Alguna vez has pensado en el sofá perfecto que encaje con tu decoración y esa idea ha existido solo en tu mente? Podemos dar vida a tu idea creando una pieza única para ti. Somos capaces de aportar soluciones al desarrollo y diseño de sofás y mobiliario para proyectos internacionales ajustándonos al diseño del cliente, a las características del proyecto y a las especificaciones técnicas y regulaciones locales requeridas.

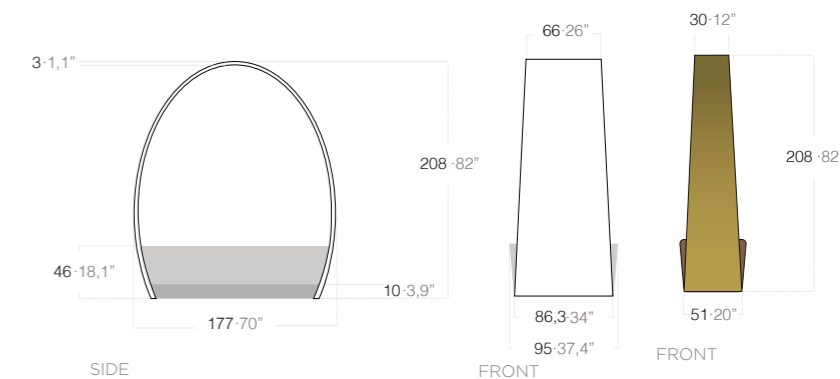

## WHAT WE DO BEST QUÉ HACEMOS

**EN** • We manufacture innovative contemporary furniture developed with the highest quality standards. Our collection is polyvalent in that it can be applied in hospitality lounge areas, corporate environments as well as residential use. We can provide an extensive list of references / installations in Hotels, Restaurants, Sports Clubs, Airport Lounges, Financial, Corporate Offices, Healthcare, Educational, Institutional, Luxury Residential and Customized Environments from around the world.

**ES** • Fabricamos mobiliario contemporáneo desarrollado con los estándares de la más alta calidad. Nuestra colección es polivalente y se ajusta a todo tipo de espacios públicos y corporativos, además de el residencial. Tenemos una amplia lista de referencias de proyectos en hoteles, restaurantes, clubs deportivos, salas business de aeropuertos, sector financiero, oficinas corporativas, sector salud, educativo, institucional, además del residencial de lujo y en el entorno “hecho a medida”.

## AROUND THE WORLD ALREDEDOR DEL MUNDO

**EN** • We have wide experience in providing furniture worldwide more than 40 years, exporting over the 5 continents.

**ES** • Tenemos amplia experiencia de más de 40 años en proveer mobiliario por todo el mundo, exportando alrededor de los 5 continentes.

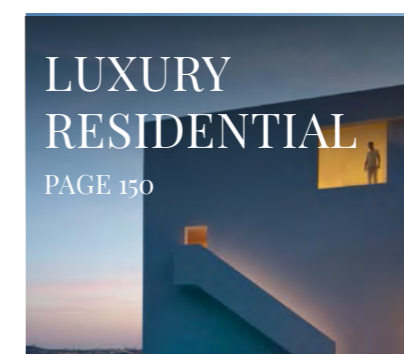
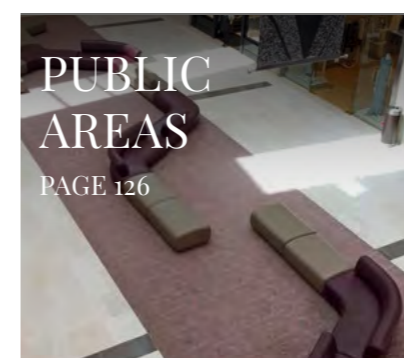
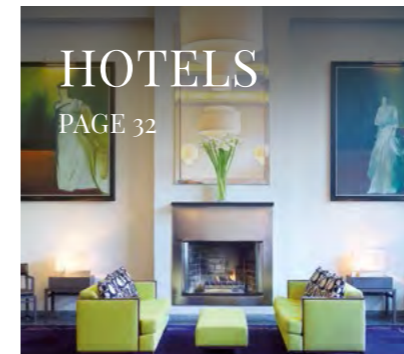

# HOTELS

# HOTELS

Hilton Abu Dhabi - U.A.E.  
Hilton Paris La Défense - Paris - France  
Hilton Charles de Gaulle - Paris - France  
Hilton Reykjavik Nordica - Reykjavik - Iceland  
Hilton Valencia - Valencia - Spain  
Hilton Madrid Airport - Madrid - Spain  
Hilton Barcelona - Barcelona - Spain  
Hilton Budapest - Budapest - Hungary  
Hilton Düsseldorf - Düsseldorf - Germany  
Hilton Stockholm Slussen - Stockholm - Sweden  
Hilton Limerick - Limerick - Ireland  
Hilton Bonn - Bonn - Germany  
Hilton Berlin - Berlin - Germany  
Hilton London Heathrow - London - U. K.  
Hilton Zurich Airport - Zurich - Switzerland  
Hilton Watford - Herts - U. K.  
Hilton National - Milton Keynes - U. K.  
Hilton Belfast - Belfast - U. K.  
Hilton Trafalgar Square - London - U. K.  
Hilton Park Lane - London - U. K.  
Hilton Wien - Vienna - Austria  
Hilton Munich - Munich - Germany  
Hilton Copenhagen Airport Hotel - Sweden  
Hilton Baku - Baku - Azerbaján  
Hilton Mexico - D.F. - Mexico  
Hilton Oslo - Oslo - Norway  
Four Seasons Hotel - Casablanca - Morocco  
W hotel - D.F. - Mexico  
Hard Rock Hotel - Panamá City - Panama  
The Malton Hotel - Killarney - Ireland  
The Carton House Hotel&Golf - Dublin - Ireland  
Carlton Hotel - Edinburgh - U. K.  
Hotel Mäster Johan - Malmö - Sweeden  
1909 Sigtuna Stads Hotel - Stockholm - Sweden  
Thistle London Hotel - London - U. K.  
42 The Calls Boutique Hotel - Leeds - U. K.  
Hotel Meerane - Meerane - Germany  
Hoteles Hesperia - Spain  
Swissôtel International Zürich - Zürich - Switzerland  
Holyrood Hotel - Edinburgh - U. K.  
The Royal York Hotel - York - U. K.  
Le Meridien Ra Beach Thalasso&Spa - Tarragona - Spain  
Le Meridien Gatwick - London - U. K.  
Le Meridien Piccadilly - London - U. K.  
Hotel Des Balances - Luzern - Switzerland  
Hotel Barajas - Madrid - Spain  
Front Air Congress Hotel - Barcelona - Spain  
Forte Posthouse Bloomsbury - London - U. K.  
Forte Hotel Gmbh - Balingen - Germany  
Forte Posthouse - Epping - U. K.  
Forte Posthouse Edinburgh - Edimburgh - U. K.  
Forte Posthouse Coventry - Coventry - U. K.  
Forte Hotel - Southampton - U. K.  
Forte Meridien - Gatwick - U. K.  
Marqués de Vallejo Hotel - Logroño - Spain  
Daresbury Park Hotel - Warrington - U. K.  
Scandic Frimurar Hotellet - Linköping - Sweden

Scandic Crawn Hotel - Göteborg - Sweden  
Scandic Hotel Skogshöjd - Södertälje - Sweden  
Scandic Hotel - Copenhagen - Denmark  
Scandic Ariadne - Sweden  
Scandic Glostrup - Copenhagen - Denmark  
Scandic Hotel - Arhus - Denmark  
Scandic Hotel - Glostrup - Denmark  
Scandic Hotel - Oslo - Norway  
Scandic Hvdovre - Copenhagen - Denmark  
Scandic Hotel Crown - Göteborg - Sweden  
Scandic Hotel Malmo St. Jorgen - Malmö - Sweden  
Star Hotel - Lund - Sweden  
Mövenpick Hotel - Lausanne - Switzerland  
Sana Hotel - Lisbon - Portugal  
Alexandros Hotel - Athens - Greece  
Hotel La Palanca - Lenzerheide - Switzerland  
Hotel Kampinski - Estepona - Spain  
Hotel Galatea - Sanxenxo - Spain  
Hotel Marques De Pombal - Lisboa - Portugal  
Hotel NH Condal - Barcelona - Spain  
Hotel NH Duc de Victoria - Barcelona - Spain  
Hotel NH Porta Barcelona - Barcelona - Spain  
Hotel NH Alcalá - Madrid - Spain  
Hotel NH Lagasca - Madrid - Spain  
Hotel NH Palacio del Duero - Zamora - Spain  
Hotel NH Barjas - Madrid - Spain  
Hotel NH Puerta de la Catedral - Salamanca - Spain  
Hotel NH Sanvy - Madrid - Spain  
Hotel NH Villa De Coslada - Madrid - Spain  
Hotel NH Ribera del Manzanares - Madrid - Spain  
Hotel NH Palacio de Oriol - Bilbao - Spain  
Hotel NH Villa de Bilbao - Spain  
Hotel NH Canciller de Ayala - Vitoria - Spain  
Hotel NH Ciudad de Valencia - Valencia - Spain  
Hotel NH Ciudad de Almeria - Spain  
Hotel NH Victoria - Granada - Spain  
Hotel NH Palacio de Santa Marta - Cáceres - Spain  
Best Western Mediterráneo - Castelldefels - Spain  
Best Western The Royal Adelaide - Windsor- U. K  
Sheraton Stockholm Hotel & Towers - Sweden  
Sheraton Hotel - Stockholm - Sweden  
Sheraton Bilbao - Spain  
Sheraton Four Points - Kuwait  
Sheraton Brussels Hotel and Towers - Belgium  
Sofitel Gatwick - London - U. K.,  
Hotel Banana City - Winterthur - Switzerland  
Hotel La Residencia - Mallorca - Spain  
The Tower Hotel - London - U. K.  
Hotel Les Demeures De Borda - Dax - France  
Hotel Confortel Suites - Madrid - Spain  
Cortijo Los Laureles - San Jose - Costa Rica  
Hotel Guggital - Hollisau - Switzerland  
Park Plaza Westminster Bridge Hotel - London - U. K.  
Hotel Princesa Daysil - Tenerife - Spain  
Hotel Troya - Tenerife - Spain  
Park Hotel - Athens - Greece  
Fintra Bay Holiday Hoy - Killybegs - Ireland

Hotel Bitacora - Tenerife - Spain  
Hotel Fira Palace - Barcelona - Spain  
Hotel Ayre Gran Via - Barcelona - Spain  
Atlas hotel - Brussels - Belgium  
Hotel Riberpuig - Andorra La Vella - Andorra  
Hotel Mercure - Andorra  
Hesperia hotel Universal - Barcelona - Spain  
Athens Plaza - Athens - Greece  
Hotel Seeblick Wismar - Germany  
Turberry Resort - Scotland  
Hotel Rungholt - Germany  
Panorama Resort & Spa - Feusisberg - Switzerland  
Fludir Hotel - Reykjavik - Iceland  
Golf beach Resort La Costa - Gerona - Spain  
Eurostar Diana Palace - Palencia - Spain  
Eurostar Gran Valencia - Valencia - Spain  
Grand Hyatt - Amman - Jordan  
Elite Hotel Knaust - Sundsvall - Sweden  
Elite Stadshotellet Lulea - Sweden  
Elite Hotel Knaust - Svitmbjalkar - Sweden  
Elite Stora Hotellet - Jönköping - Sweden  
Elite Hotel Savoy - Malmö - Sweden  
Elite Hotel - Biel - Switzerland  
Elite Hotel Arcadia - Stockholm - Sweden  
Elite Marina Tower Plaza - Stockholm - Sweden  
Elite Park Avenue Hotel - Goteborg - Sweden  
Elite Stora Hotel - Örebro - Sweden  
Radisson Blu Amsterdam - Netherlands  
Radisson Blu, Scandinavia, Norway  
Radisson Sas Hotel - Tallinn - Estonia  
Sas Radisson Royal Viking - Stockholm - Sweden  
Sas Hotel Expo 2000 - Hannover - Germany  
SassRadisson Saga - Reykjavik - Iceland  
Sas Radisson Hotel - Oslo - Norway  
Sas Radisson Royal Garden - Trondheim - Norway  
Sas Radisson Hotel Hannover - Germany  
Catalonia Hotel Berna - Barcelona - Spain  
Catalonia Hotel Atenas - Barcelona - Spain  
Catalonia Hotel Forum - Brussels- Belgium  
Catalonia Riviera Maya - Mexico  
Catalonia Hotel El Pilar - Zaragoza- Spain  
Catalonia Suite - Barcelona - Spain  
Abba Hotel - Burgos - Spain  
Abba Acteon - Valencia - Spain  
Abba Hotel - Castellon - Spain  
Five Lakes Ab Hotel, Golf & Spa - Essex - U. K.  
Berns Hotel - Stockholm - Sweden  
Hotel Riddargatan - Stockholm - Sweden  
Hotel Mediterraneo - Castelldefels - Spain  
Hotel Savoy - Fr. Rogoe - Köln - Germany  
Posthouse Kensington - London - U.K.  
Holiday Inn Express - Celaya - Mexico  
Holiday Inn Express - Quedgeley - U.K.  
Holiday Inn Express - Gateshead - U.K.  
Holiday Inn Express - Lichfield - U. K.  
Holiday Inn Express - Southampton - U.K.  
Holiday Inn Express - London - U. K.

Holiday Inn Express - Peterborough - U.K.  
Holiday Inn Fulda - Fulda - Germany  
Holiday Inn Essen Scandic - Essen - Germany  
Holiday Inn Bloomsbery - London - U.K.  
Holiday Inn Stuttgart - Germany  
Holiday Inn Mannheim City Centre - Germany  
Holiday Inn Swindon - U. K.  
Andorra Palace - Andorra  
Hotel Skogshöjd - Sodertalje - Sweden  
Memory Hotel - Kista - Sweden  
Hotel Brennerserhof - Köln - Germany  
Insel Hotel Rügen - Göhren - Germany  
Hotel Villa Hammerschmiede - Pfnatal - Germany  
Hotel Kleines Meer - Waren Ad Muritz - Germany  
Hotel Graf - Zeppelin - Germany  
Gastberger Hotelbetriebe - Schloss Am Wolfgangsee - Austria  
Gallery Hotel - Sweden  
Senab Lf Lager - Sundbyberg - Denmark  
Hotel Las Americas - Yaiza - Spain  
Gran Hotel Benasque - Huesca - Spain  
Hotel Playa Dorada - Lanzarote - Spain  
Hotel Tryp Alameda - Málaga - Spain  
Mount Klara Bungalows - Malaysia  
The Royal Adelaide hotel Windsor - U. K.  
Metropolitan Hotel - Athens - Greece  
Crowne Plaza Hotel - Liverpool - U. K.  
Crowne Plaza Hotel - Marlow - U. K.  
Crowne Plaza Hotel - London - U. K.  
Crowne Plaza Hotel - Dubai - U.A.E.  
Fitzwilliam Hotel - Dublin - Ireland  
Sligo Park Hotel - Galway - Ireland  
Sligo Park Hotel - Sligo - Ireland  
The Quality Edvard Grieg Hotel - Bergen - Norway  
Hotel Silken - Barcelona - Spain  
Hotel Sommerau - Switzerland  
Hotel Oasis Be Live Resort - Lanzarote - Spain  
Hotel Quemado - Casablanca - Morocco  
Hampton Hotel - Needwood - U. K.  
Hotel Juan De Austria - Valladolid - Spain  
Hotel Rex - Kalamata - Greece  
Sercotel Luz - Castellón- Spain  
Cumberland Hotel - London - U. K.  
First Hotel Arsta - Arsta - Sweden  
Marknadsdomstolen Hotel - Stockholm - Sweden  
Hotel Tylosand - Halmstad - Sweden  
AB Skipper Hotel - Barcelona - Spain  
Corinthia Hotel - Antwerp - Belgium  
Freys Hotel - Stockholm - Sweden  
Hotel Krebs - Bern - Switzerland  
Alpina Hotel Klosters - Emmen - Switzerland  
Hotel Rigi Hof - Emmen - Switzerland  
Hotel Schweizerhaus - Maloja - Switzerland  
Hotel Seedamm - Pfäffikon - Switzerland  
Vinci Frontaura Hotel - Valladolid - Spain  
Royal Bavaro Resort&Golf - Rep. Dominicana  
Seaham Hall Hotel - Durham - U. K.  
Paramount Hotel - Oxford - U. K.

Confortel Calas de Conil Roche - Spain  
Hotel QGat Suites - Sant Cugat - Spain  
Fleming's hotel - München - Germany  
Posthouse Epping - Essex - U. K.  
Hotel Arona - Tenerife - Spain  
Hotel Puerta de Sahagún - León - Spain  
The Hague Marriott Hotel - The Hague - Netherlands  
Marriot U.S.A.  
Marriott Health & Country Club - Yorkshire - U. K.  
Marriott Frankfurt Lagerhalle - Germany  
Hotel Sensity Chillout - Cala Ratjada - Mallorca - Spain  
Hotel Sensity Triton - Cala Ratjada - Mallorca - Spain  
Atlas Hotel - Brusels - Belgium  
AC Hotel - Palencia - Spain  
La Goleta Hotel de Mar - Pollença - Spain  
Hotel Eva Park - Cala Ratjada - Mallorca - Spain  
Hotel Cala Blanca - Santa Eulalia - Ibiza - Spain  
White Island Resort & Spa - Ibiza - Spain  
Hotel Palmira - Ibiza - Spain  
Hotel Noelia - Tenerife - Spain  
Hotel Dunes - Doha - Qatar  
Hotel Krone - Sarnen - Switzerland  
Hotel Cassandra - Barcelona - Spain  
Iberostar Hotels & Resorts - Jamaica  
Iberostar Hotels & Resorts - Ibiza - Spain  
Hotel Royal Iberostar - Playa De Palma - Spain  
Hotel Holt - Reykjavik - Iceland  
Hotel Santa Fe - Santa Margalida - Mallorca - Spain  
Hotel 53 Piccadilly York - U.K.  
The Landau - Fulham - U.K.  
Hotel Mas de la Costa - Teruel - Spain  
Arc En Ciel Hotel - El Khroub - Algeria  
Nexus Suites Hotel - Valladolid - Spain  
Sana Hotels - Lisbon - Portugal



# La Goleta

Hotel de Mar,  
Pollença, Spain

**Models:**  
**Cuc** (sofa)  
**Madalena** (footstool)  
**Riverso** (chair)





Hotel  
Es Pla Ibiza  
Ibiza, Spain

**Models:**  
**Cayman** (sofá)  
**Hexa** (chair)  
**Kanel** (lounge chair)





# SB Corona Hotel

Tortosa, Spain

**Models:**  
**Pasarela** (armchair)  
**Opalina** (lounge chair)  
**Opal** (armchair)

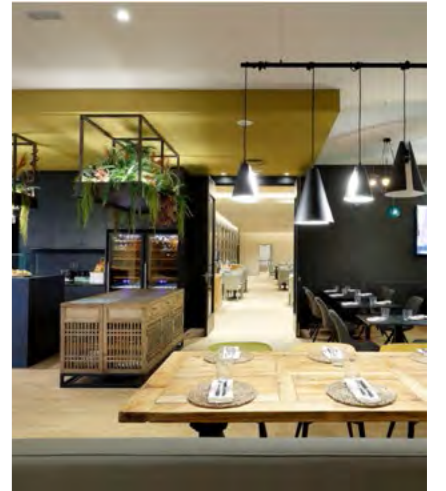

# Kaktus Playa Hotel

Spain



**Models:**  
**Nicolay** (armchair, footstool)  
**Transit** (sofa)





# Hilton Hotel

Berlin, Germany



Model:  
Glamour (sofa)



# Hilton Hotel

Reykjavik, Iceland



**Models:**  
**Artemis** (armchair)  
**Interval** (sofa, armchair)

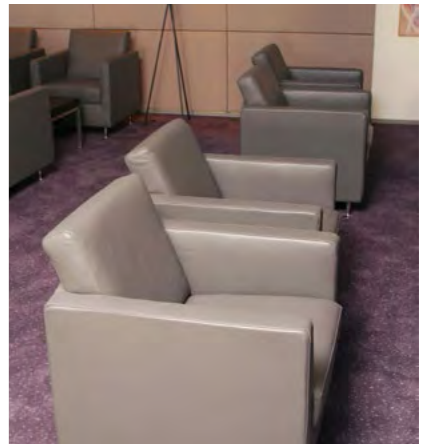

# Carton House

Hotel, Golf & Leisure,  
Maynooth, Kildare, Ireland

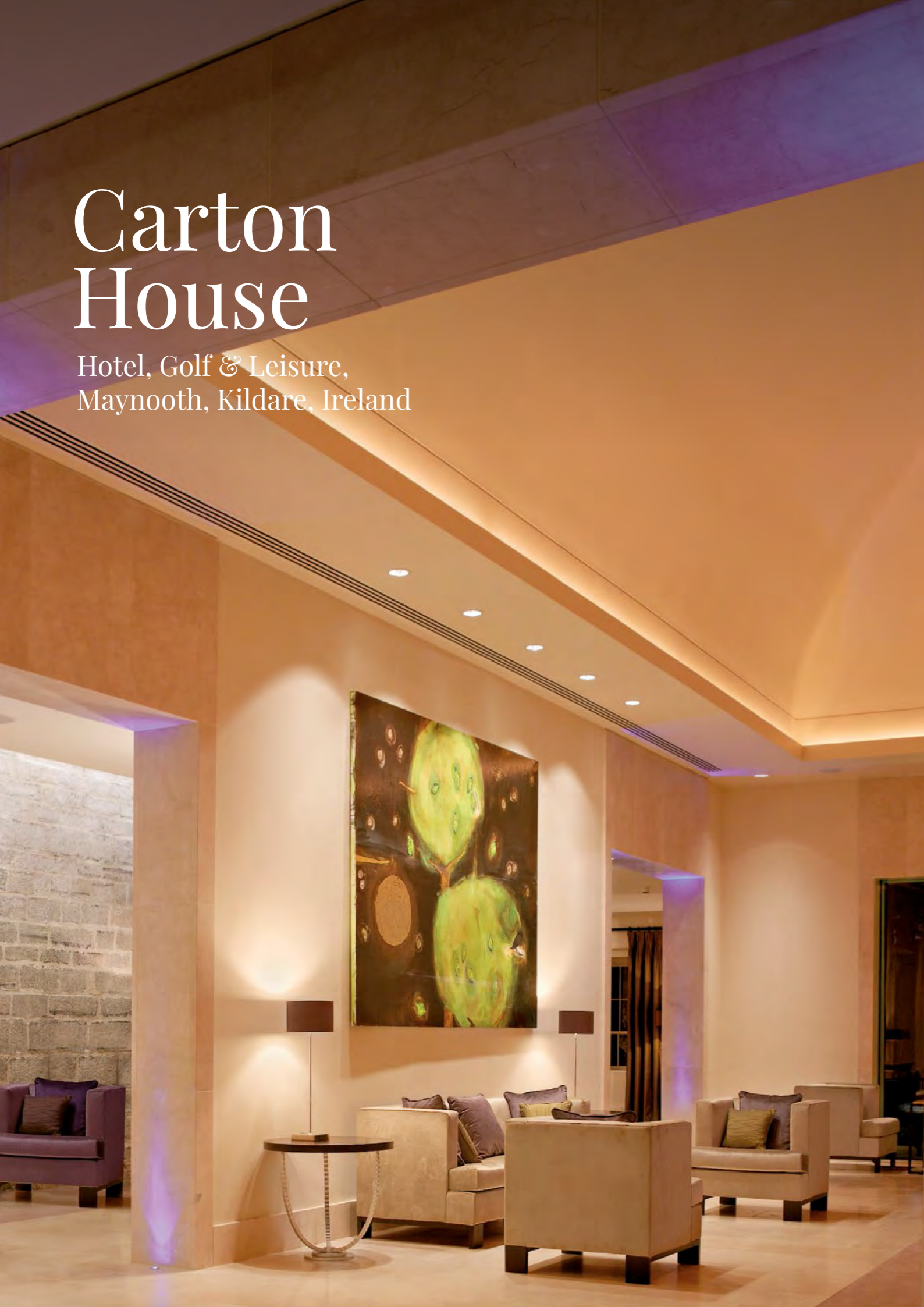

**Models:**  
**Invader** (sofa, armchair)  
**Pony** (chair)



# Märchenhotel Bellevue

Braunwald, Switzerland



**Models:**  
**Open Air** (sofa)  
**Opalina, Rosetta** (lounge chair)

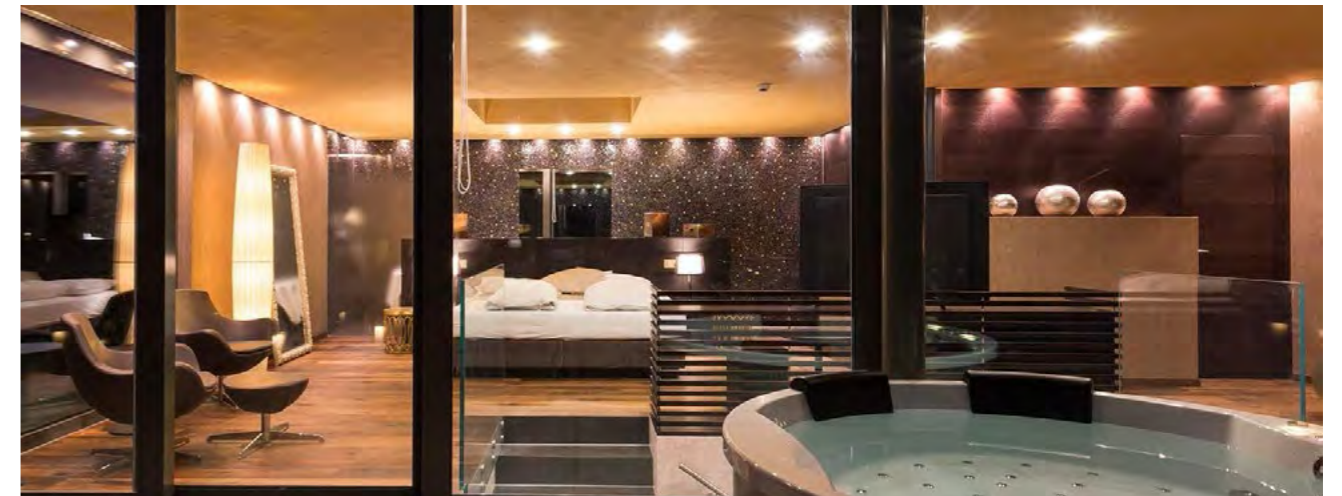

# Le Bayonne

France



**Models:**  
**Riverso** (chair)  
**Elder** (sofa)  
**Kanel** (lounge chair)





# Riu Chiclana

Cádiz, Spain

**Models:**  
**Cuc** (sofa)  
**Madalena** (footstool)  
**Opalina** (armchair)

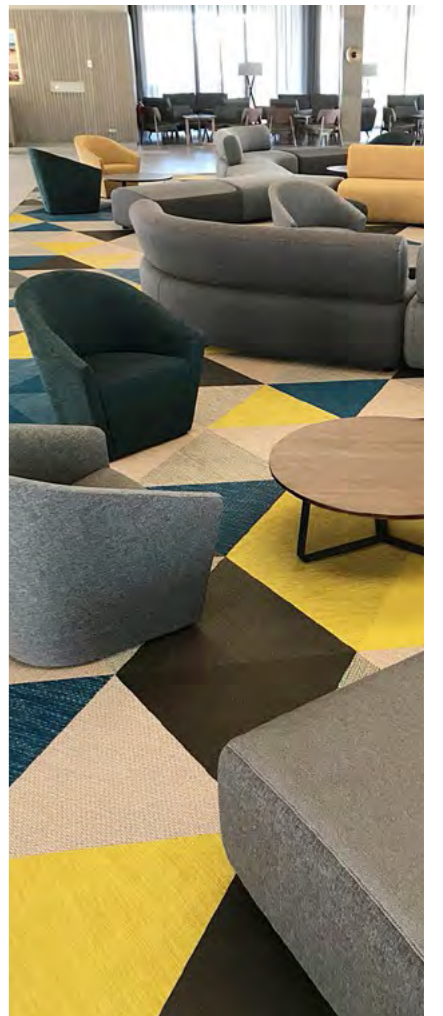
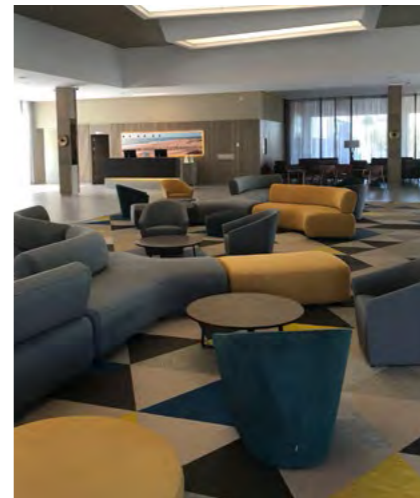

---

Google Head Offices - Dublin - Ireland  
Swarovski Head Quarters in Europe - Barcelona - Spain  
Powerade Corporate Offices - Barcelona - Spain  
MNC Office Campus - Bangalore - India  
Oryx GTL Head Offices Woqod Towers - Doha - Qatar  
Torre Agbar Oficinas centrales Aguas de Barcelona - Spain  
Dragados Head Offices - Spain  
Astellas Pharma - Business Campus - Dublin - Ireland  
Abbey Business Center - Heathrow - U. K.  
Colling Wood Business Center - London - U. K.  
Aw. Co. Corporate Offices - Durham - Unites States  
Gilead Offices - Madrid - Spain  
Ibercon Corporate Offices - Palma de Mallorca - Spain  
Tecnitagus-Siva - Almada - Portugal  
Transwaggon Ab - Helsingborg - Sweden  
Alfa Inredningar - Stockholm - Sweden  
Centro empresarial Destro - Valencia - Spain  
Front Air Congress - Barcelona  
Globex Business Centres Inc - Tower II of the Premium Luxury  
"The Gate"- Doha - Qatar  
World Trade Center - Barcelona - Spain  
Mccann Erickson Advertising Ltd. - Dublin - Ireland  
Cisco Systems Int. B.V - Amsterdam - Netherlands  
Cisco Systems - Bellshill - U. K.  
Rijsterborgh Vastgoed Office - Amsterdam - Netherlands  
Cannon - Madrid - Spain  
Carnello & Headquist Offices - Stockholm - Sweden  
Ericsson Telecom Ab - Hägersten - Sweden  
Media Surface Dallas&Dallas - Glasgow - U. K.  
Shopfit Ltd - Hertfordshire - U. K.  
FDF Lawyers - Spain  
Holmes O'malley Sexton Solicitors - Offices - U. K.  
Brabners Chaffe Street - Manchester - U. K.  
The Morgate Business - U. K.  
Independant Televisual Group - Dublin - Ireland  
KMD Architects - Mexico D.F. - México  
Schaudt Mikrosa Corp. Offices - Leipzig - Germany  
Imagen Tv edificio corporativo - México  
Sadeer Trading & Contacting offices - Kuwait  
Hogan Lovells Lawyers N.Y. - U.S.A.  
Discovery Bonita Springs head quarters FL - U.S.A.  
Edificio Il.Jumina Oficinas Barcelona - Spain  
Envia Mitteldeutsche Energie AG Enviam - Chemnitz - Germany  
Oficinas Centrales Riviera - Ciudad de México - México  
Gabinet Administratiu oficinas - Tarragona - Spain  
WOW MPG showroom - Porto - Portugal  
Caesars Palace Forum Las Vegas - U.S.A.  
SEC Saudi Electricity Company Corporate HQ  
buildings - Riyadh - Saudi Arabia

# Corporate Offices

# Caesars Palace

Caesars Palace forum  
Las Vegas, Nevada



Model:  
Customized (sofa bench)







# Swarovski

European Headquarters,  
Barcelona, Spain



Model:  
Kanel (lounge chair)

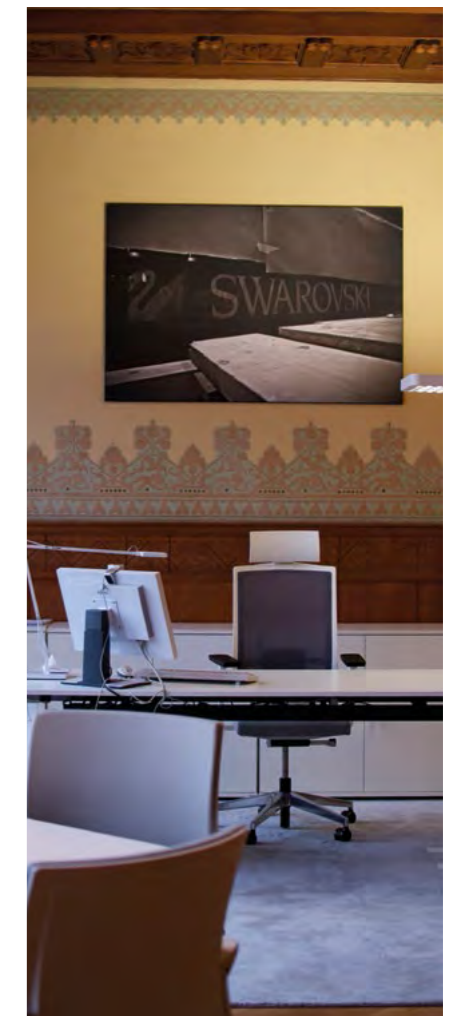
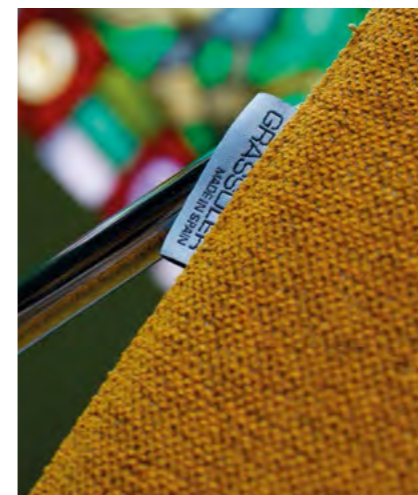

# Corporativo Imagen TV

Ciudad de México, México



**Models:**

**Elder** (sofa, armchair, footstool)

**Place** (chaiselongue)





# Powerade

European Headquarters,  
Barcelona, Spain



**Models:**  
**Rosetta** (lounge chair)  
**Transit MMS** (sofa)



**Models:**

**Rosetta** (lounge chair)

**Transit MMS** (sofa)



# Chicago

Office showroom



**Models:**  
**Berna, Berlin** (lounge chair)  
**Elder** (sofa, armchair, footstool)  
**Kanel** (lounge chair)

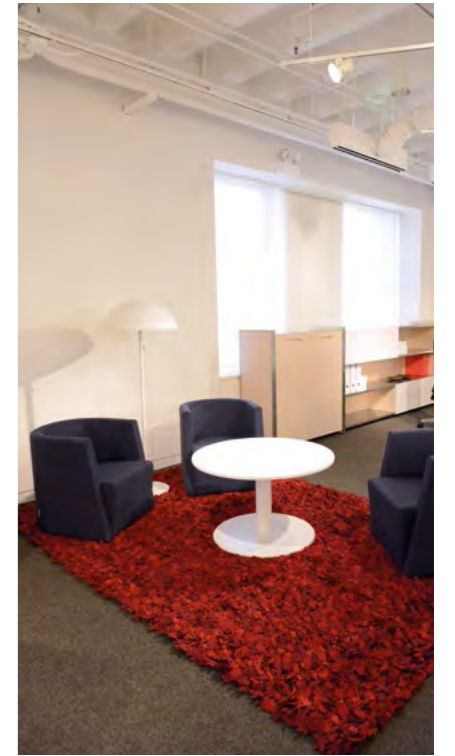



# Mikrosa

Schautd Mikrosa Corp. offices,  
Leipzig, Germany

Models:  
Euphoria XXI (sofa)

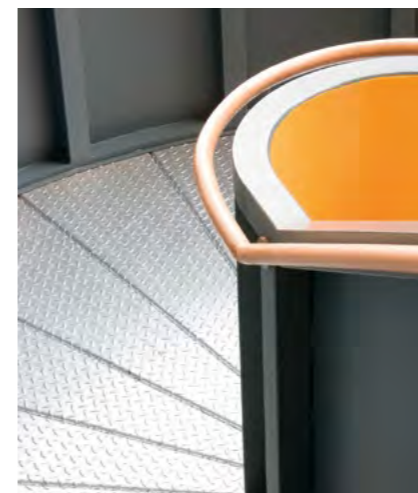

---

Rockefeller Center Cafe - New York - United States  
The Qube restaurant & cafe - Dubai - U.A.E.  
Pinot's Restaurant - Dublin - Ireland  
Restaurante Spisen - Stockholm - Sweden  
Restaurant Hans Im Glück - Kloten - Switzerland  
Barça Bar - Castlefield, Manchester - U. K.  
Tragabuches - Málaga - Spain  
L'Ortolan Restaurant - Berkshire - U. K.  
Spaguetti House - London - U. K.  
Meson Escudero - Málaga - Spain  
Duchesse Restaurant - Shiedam - Netherlands  
The Railway Bar - Donegal - Ireland  
Arnotts Café & Restaurant - Dublin - Ireland  
The Tannery Restaurant - Waterford - Ireland  
Café Pasta - London - U. K.  
Pasta Di Milano Restaurante - London - U. K.  
Cha Tea Bar - Bristol - U. K.  
Pizza Express - Surrey - U. K.  
Pizza Express - Oxted - U. K.  
Pizza Express Ltd - London - U. K.  
Pizza Express Ltd - Salisbury - U. K.  
Pizza Express Ltd - Cheshire - U. K.  
Pizza Express Ltd - Muswell Hill - U. K.  
Pizza Express Ltd - Humberside - U. K.  
Pizza Express Ltd - Bournemouth - U. K.  
Pizza Express Ltd - Darlington - U. K.  
Pizza Express Ltd - Knutford - U. K.  
Pizza Express - Almond Vale - U. K.  
Pizza Express - Shrewsbury - U. K.  
Pizza Express - Kent - U. K.  
Pizza Express Ltd - Suffolk - U. K.  
Pizza Express Ltd Sutton - Coldfield- U. K.  
Pizza Express - Middlesex - U. K.  
Pizza Express - Essex - U. K.  
Pizza Express Ltd - Plymouth - U. K.  
Pizza Express - Teddington - U. K.  
Pizza Express Head Office - Middlesex - U. K.  
Pizza Express - Greenhithe - U. K.  
Serafina Café - Jeddah - Saudi Arabia  
Cafeteria Museu Maritim - Barcelona - Spain  
Ambassador a l'Opera restaurant Hotel - Zurich - Switzerland  
Restaurante Portofino, White Island Resort & Spa - Ibiza - Spain

# Restaurants

# White Island

Resort & Spa, Ibiza, Spain



Model:  
Customized (sofa)

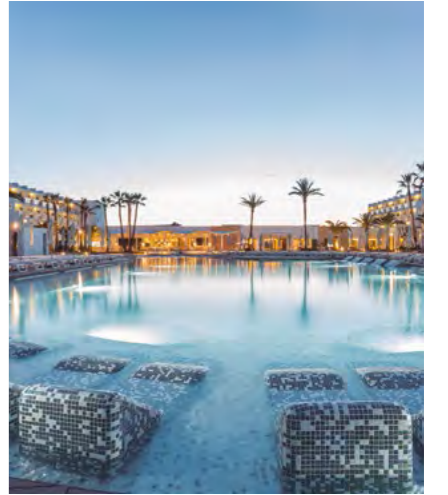
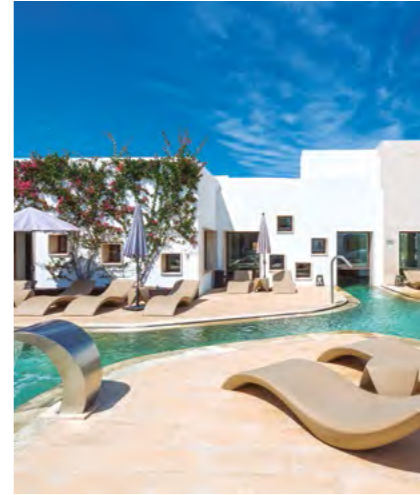



# BG Hotel El Rei del Mediterrani

Alcudia, Spain



Model:  
Customized (sofa)



# Rock Centre Cafe

Rockefeller Centre,  
N.Y.



Model:  
Party (chair)

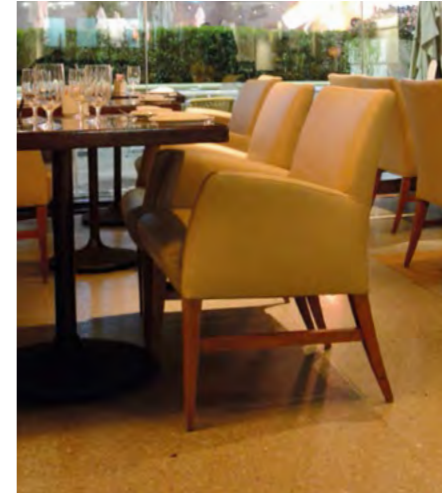

# The Qube

Restaurant & Cafe,  
Dubai U.A.E.



Model:  
Every (sofa, armchair)

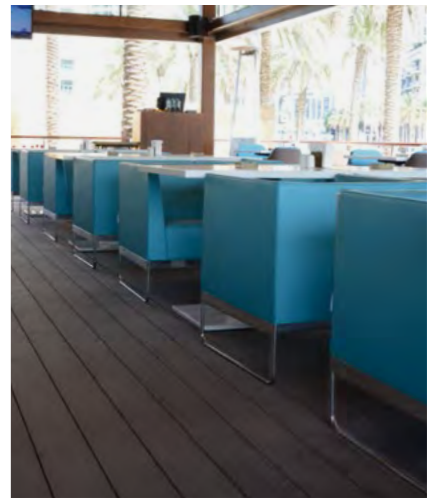
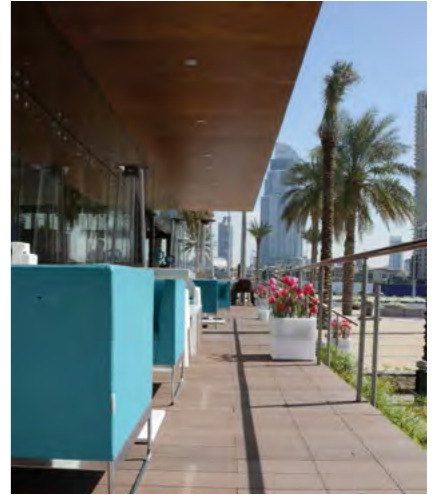

# La Liga Lounge Sheraton Grand Doha

Doha, Qatar

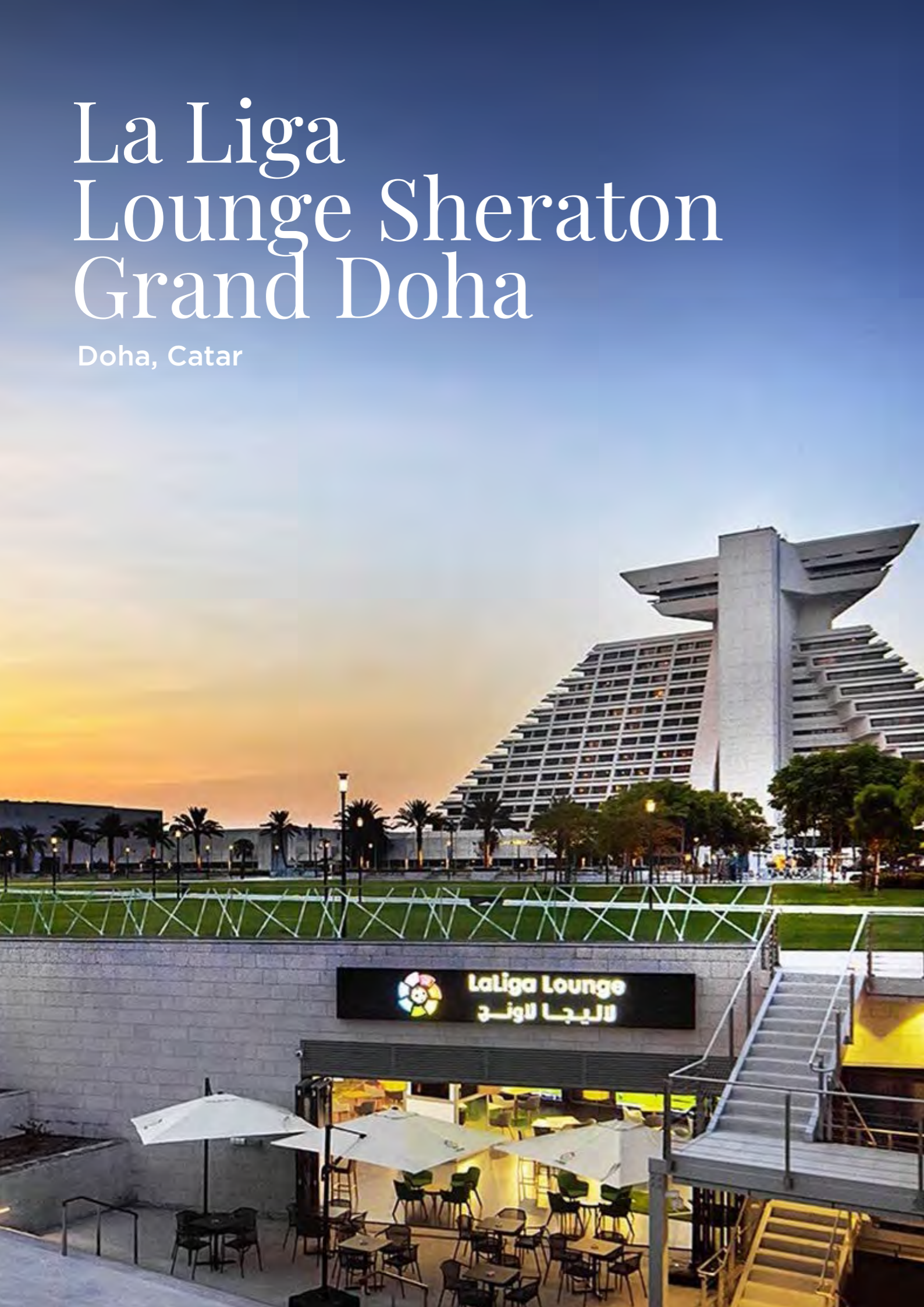

**Models:**  
Interval (sofa)  
Riverso (chair)  
Turin (chair)

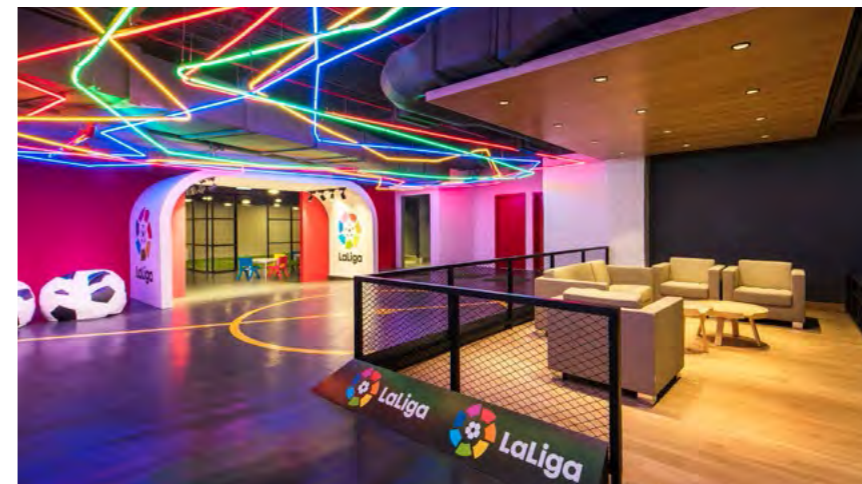

# Crowne Plaza

Festival City, Dubai, U.A.E.



- Models:**  
**Berna** (lounge chair)  
**Customized** (chair)  
**Jack** (sofa)  
**Kanel** (lounge chair)  
**Parade** (lounge chair)  
**Rosetta** (lounge chair)



---

International Dubai Airport Terminal 3 Emirates - Airlines lounges (Business Class, First Class and VIP diplomatic lounge) - Dubai- UAE  
International Dubai Airport Terminal 3 - Extensión Fase II - Emirates Airlines lounges (Business Class, First Class lounge) - Dubai - UAE  
British Airways - Didsbury - U. K.  
Dnepropetrovsk International Airport lounges - Ukraine  
Swissair - Geneva - Switzerland  
Manchester Airport - Manchester - U. K.  
King Khalid Int. Airport Riyadh - Saudi Arabia  
Dakar International Airport Business Lounge - Senegal  
Gatwick London International Airport - London - U. K.  
British Airways Office Suite - Suffolk - U. K.  
London City Airport - London - U. K.  
London Heathrow International Airport - U. K.  
Business Lounge Swissair JFK - New York - United States  
Vip Lounges Spanair - Palma de Mallorca - Spain  
Changi International Airport - Changi - Singapore  
Dublin International Airport T2 - Dublin - Ireland  
Sala de Autoridades T1 aeropuerto de Barcelona - Spain  
Sala de Autoridades aeropuerto de Vigo - Spain  
Air Canada Business Lounge - Canada  
Business Lounge Sala Cibeles - Aeropuerto Barajas - Madrid - Spain  
Al Fursan Lounge - King Khalid Airport - Riyadh - Saudi Arabia  
Saudi Private Aviation - Jeddah - Saudi Arabia  
Dasman Business Lounge Kuwait Int. Airport - Kuwait  
Al Mubarakiya Lounge T4 Int Airport - Kuwait  
Alfursan Lounge Jeddah King Abdulaziz Int Airport - Saudi Arabia  
Los Cabos Lounge San José del Cabo Airport - México  
Tramuntana Sala Vip Aerop. Mahon - Menorca - Spain  
Puerta del Sol Lounge T3 Madrid Adolfo Suarez Airport - Spain  
Plaza Mayor Lounge T4 Madrid Adolfo Suarez Airport - Spain  
Neptuno Lounge T4 Madrid Adolfo Suarez Airport - Spain

# Airport Lounges



# Mallorcair FBO

Terminal of private jets, Mallorca, Spain



**Model:**  
**Rosetta** (lounge chair)  
**Customized** (sofa)

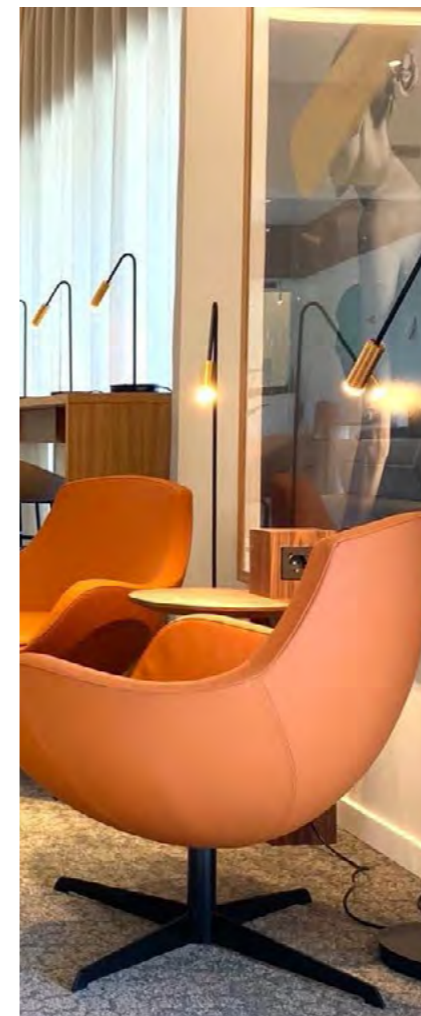

# Tramuntana Int. Lounge Airport

Mahón, Menorca

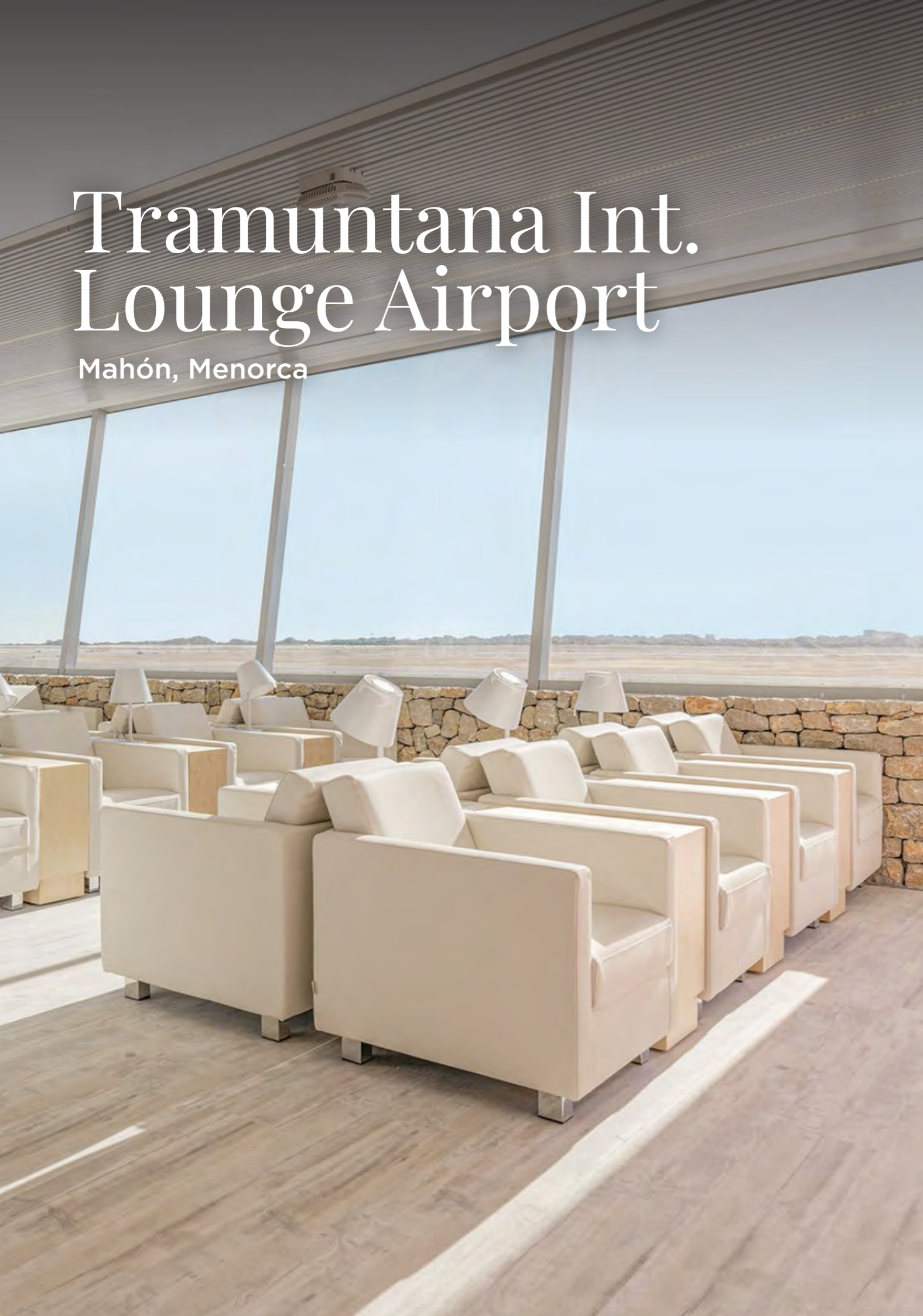

Models:  
Artemis (lounge chair)





# Al-Mubarakiya Lounge

KW Airlines  
Kuwait International  
Terminal 4



**Models:**  
**Glamour** (armchair)  
**Oxygen** (sofa)  
**Opalina** (lounge chair)  
**Salvia** (table)



**Models:**  
**Glamour** (armchair)  
**Oxygen** (sofa)  
**Opalina** (lounge chair)  
**Salvia** (table)

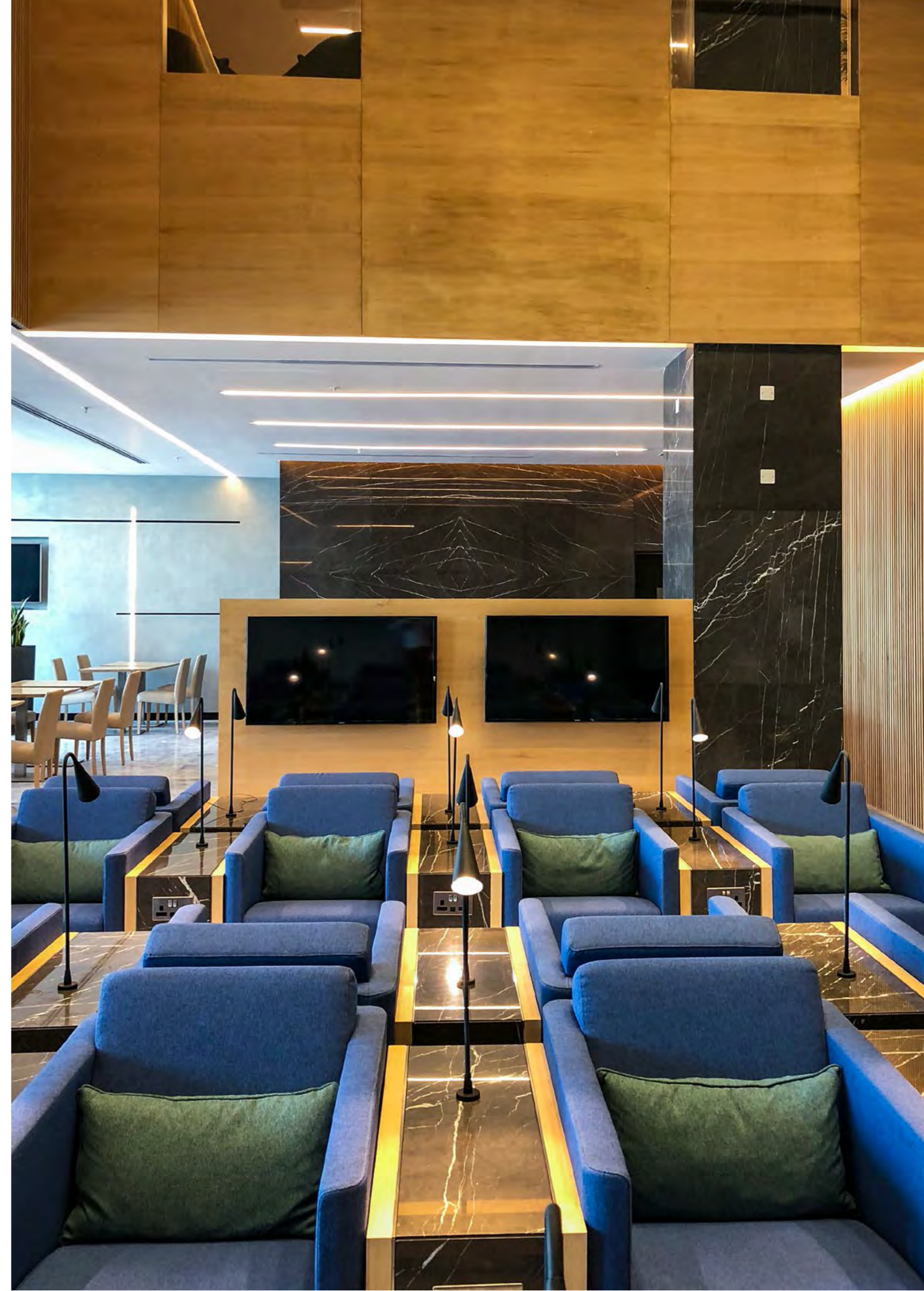
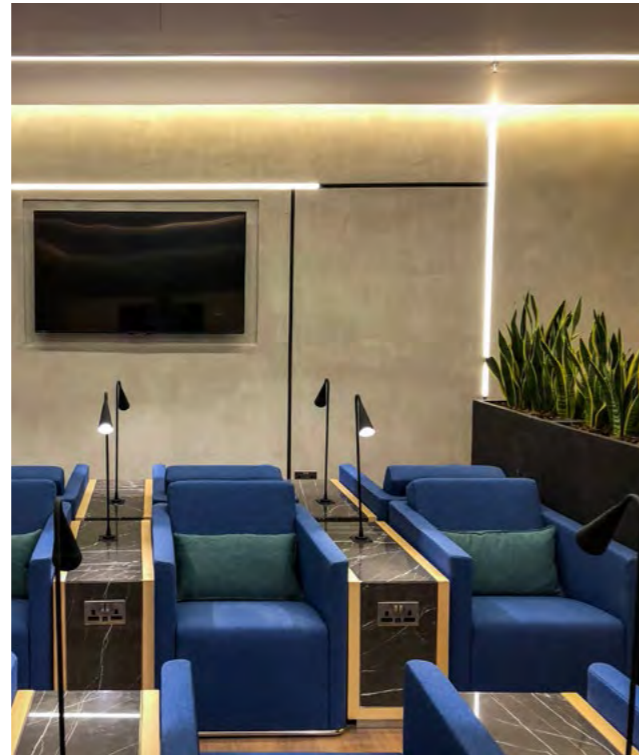

# Kuwait Airlines

Business Lounge Int.  
Airport, Kuwait



**Models:**  
**Berlin** (lounge chair)  
**Intruder** (sofa, armchair)  
**Opalina** (lounge chair)  
**Parade** (lounge chair)

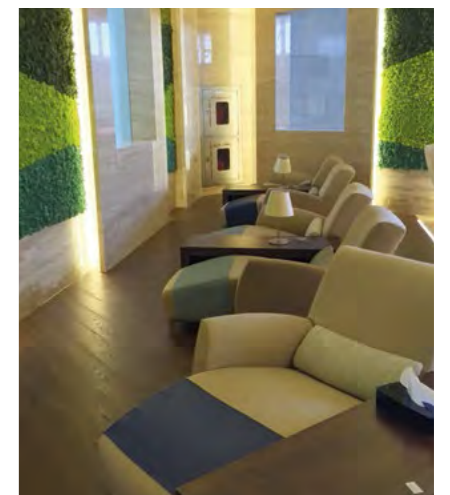
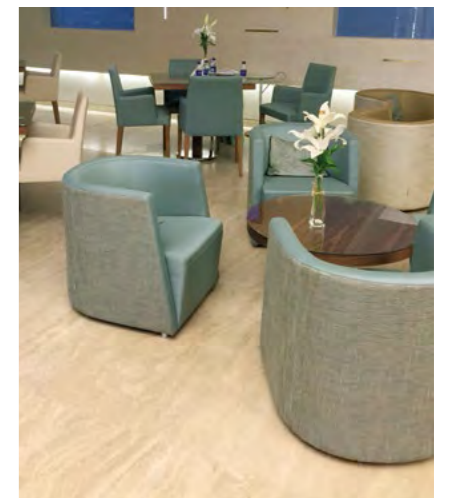

# Emirates Airlines

First Class Lounge,  
Terminal 3 Dubai Int.  
Airport U.A.E.



**Models:**  
**Diamond** (sofa, armchair, footstool)  
**Intruder** (sofa, armchair)  
**Invader** (sofa, armchair, footstool)

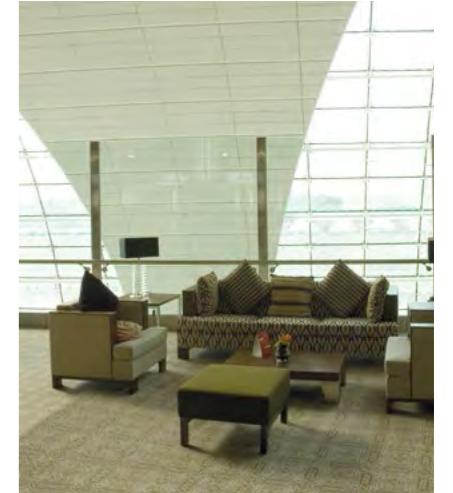



# Emirates Airlines

Business Class Lounge  
Terminal 3 Dubai Int. Airport U.A.E.

Model:  
Euphoria XXI (sofa, armchair)

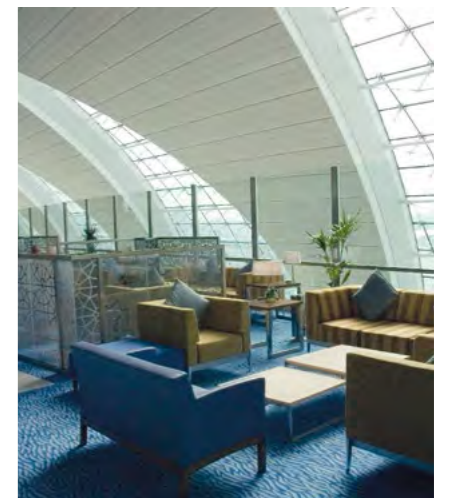



# Swissair

Business and First Class Lounge  
JFK Int Airport, N.Y.

Model:  
Artemis (lounge chair)

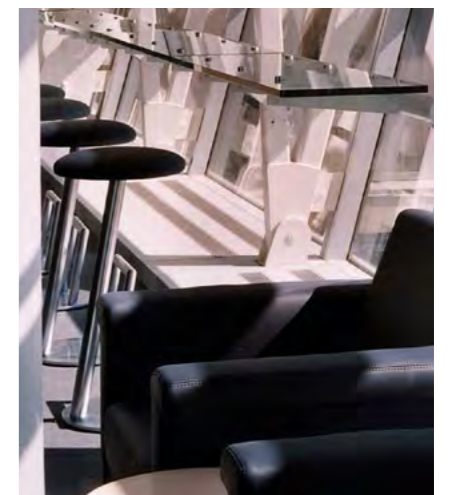

---

Mafraq Hospital, Presidential Wing - Abu Dhabi - U.A.E.  
Kuwait Specialized Eye Center - Kuwait  
Kilani Health Care Institute, Farah Hospital - Amman - Jordan  
Klinik Hohenegg - Meiten - Switzerland  
Latifa Hospital - Dubai - U.A.E.  
Cork University Maternity Hospital - Wilton, Cork - Ireland  
Hospital de la Universidad de los Andes - Santiago de Chile - Chile  
Clinica Rotger - Palma de Mallorca - Spain  
Epilepsie Klinik - Zürich - Switzerland  
Clinica Baviera - Valladolid - Spain  
Reha Klinik - Barby - Germany  
Reha Klinik - Buchow - Germany  
Reha Klinik - Templin - Germany  
Ciba Geigy - Västra Frölunda - Sweden  
Ciba Geigy - Göteborg - Sweden  
Colegio de Farmaceuticos - Barcelona - Spain  
Residencia Geriatrica Catite - Barcelona - Spain  
Clínica San Jordi - Barcelona - Spain  
Clínica Tres Torres - Barcelona - Spain  
Claremont Hospital - Sheffield - U. K.  
Mio Sportklinik Gelenzentrum - Leipzig - Germany  
Nuffield Health Hospital - Taunton, Somerset - U. K.  
Nuffield Health Hospital - Chandlers Ford, Eastleigh - U.K.  
Nuffield Health Hospital - Warwick- U. K.  
Nuffield Health Hospital - Guildford- U. K.  
Nuffield Health Hospital - Bournemouth - U. K.  
Nuffield Health Hospital - Hampshire - U. K.  
Nuffield Health Hospital, Tunbridge Wells - Kent - U. K.  
Nuffield Health Hospital - Brentwood - U. K.  
Nuffield Health Hospital - Chelmsford - U. K.  
Nuffield Health Hospital - Brighton - U. K.  
Nuffield Health Hospital - Leicester - U. K.  
Nuffield Health Hospital - Wessex - U. K.  
Nuffield Health Hospital - Cambridge - U. K.  
Nuffield Health Hospital - Grosvenor - U. K.  
Nuffield Health Hospital - Oxford - U. K.  
Nuffield Health Hospital - Exeter - U. K.  
Nuffield Health Hospital - Manchester - U. K.  
Nuffield Health - Woking - Surrey - U.K.  
Nuffield Health - Newcastle-Under-Lyme - U.K.  
Nuffield Hospital - Foxhall - U.K.  
Nuffield Health Tees Hospital - Norton - Stockton On Tees - U.K.  
Nuffield Health Cambridge Hospital - Cambridge - U.K.  
Igiás Melathron Clinic - Athens - Greece  
Clínica La Luz - Madrid - Spain  
Hospital Clínica Perpetuo Socorro - Lleida - Spain  
Westbay Medical Clinic - Doha - Qatar  
Helios Klinikum - Borna - Germany  
West Bay Medicare Center - Doha - Qatar  
Clover Center Mazaya Clinic - Kuwait  
Gelenzentrum - Leipzig - Germany

# Healthcare

# Kuwait Specialized Eye Center

Kuwait



**Models:**

**Every** (sofa, table)

**Grammy** (lounge chair)

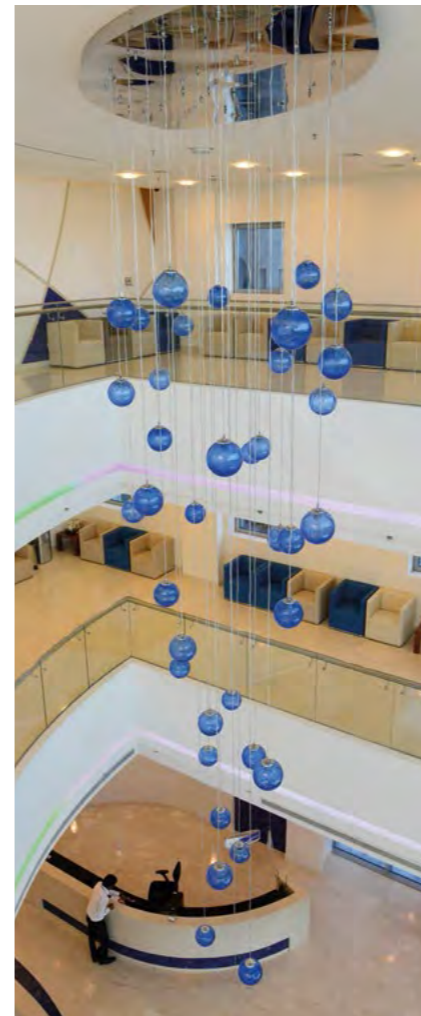



**Models:**

**Every** (sofa, table)

**Grammy** (lounge chair)



# Al Kharafi Activity Center for kids

For kids with special needs,  
Kuwait

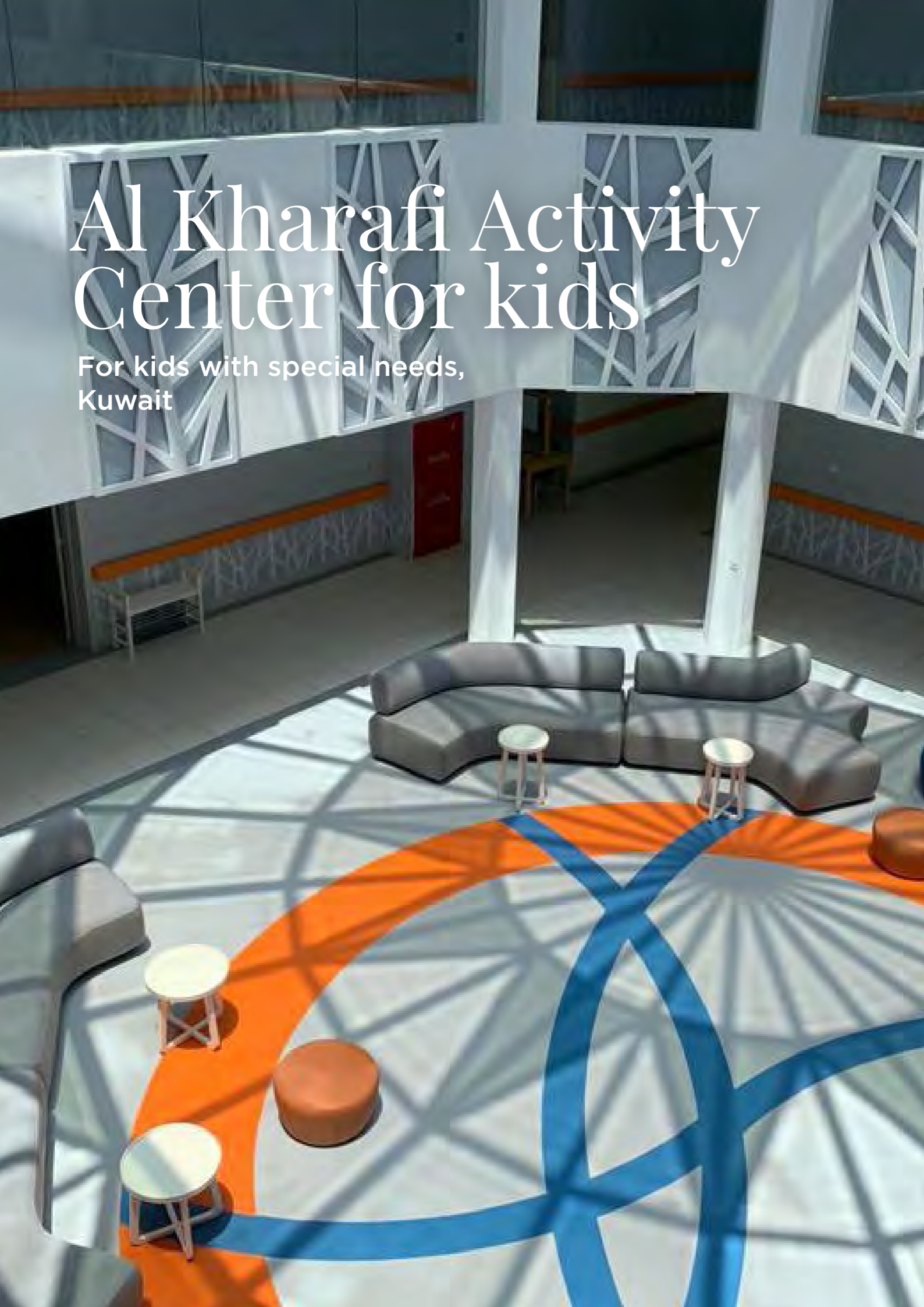

**Models:**  
**Cuc** (sofa)  
**Madalena** (footstool)



# Nuffield Health

More than 20 Hospitals around England



**Models:**  
**Artemis** (sofa, armchair)  
**Parade** (lounge chair)  
**Person** (sofa)





# Clover Centre Mazaya Clinic

Kuwait



**Model:**  
**Artemis** (sofa, armchair)

---

Al Rajhi Bank Corporate branches in Saudi Arabia - Saudi Arabia  
Banco Santander - México  
QIIB Qatar International Islamic Bank - Doha - Qatar  
Doha Bank - Doha - Qatar  
Union Bank - Zürich - Switzerland  
La Caixa despachos de dirección general - Barcelona - Spain  
Bank of Ireland - Liverpool - U. K.  
NatWest Cadogan Place - London - U. K.  
NatWest Group Tunbridge Wells - Kent - U. K.  
Coutts NatWest Group Bristol - Avon - U. K.  
Coutts NatWest Group - Cambridge - U. K.  
Banco Bilbao Vizcaya - Madrid - Spain  
American Express Offices Europe - London - U. K.  
Santander Select America Latina - Mexico  
Central Bank Tower - Doha - Qatar  
Burgan Bank - Kuwait  
ANB Bank - Saudi Arabia  
BBVA Santa Barbara - Madrid - Spain  
Bancomer Oficinas - México  
Al Ahli Bank - Doha - Qatar

# Financial

# Al Ahli Bank

Doha, Qatar



**Model:**  
Kanel (lounge chair)

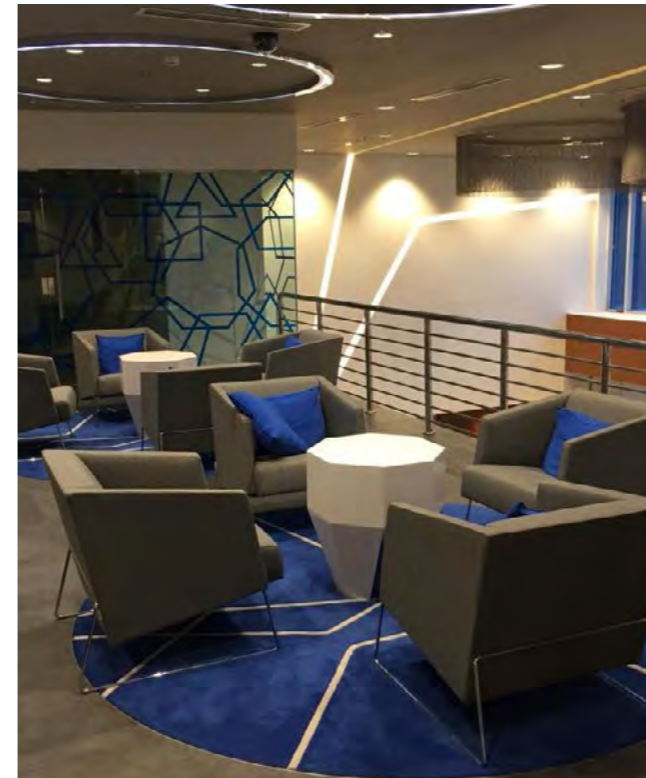



# Al Rajhi Bank

700 branches,  
Saudi Arabia



Model:  
**Rosetta** (lounge chair)

# Santander Select

México



**Model:**  
**Rosetta** (lounge chair)





# Burgan Bank

Kuwait



- Models:**  
**Cuc** (sofa)  
**Customized** (sofa)  
**Kanel** (lounge chair)  
**Opalina** (lounge chair)

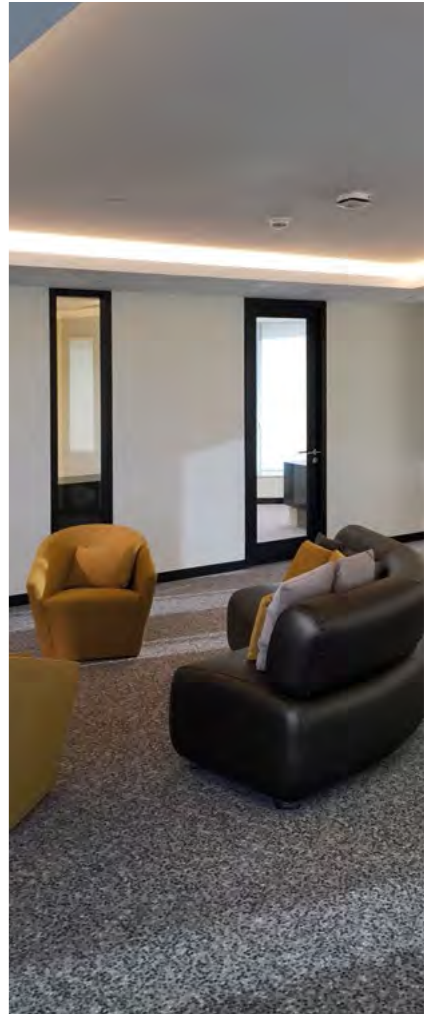
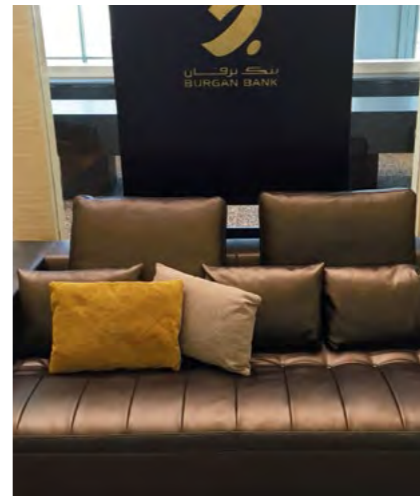
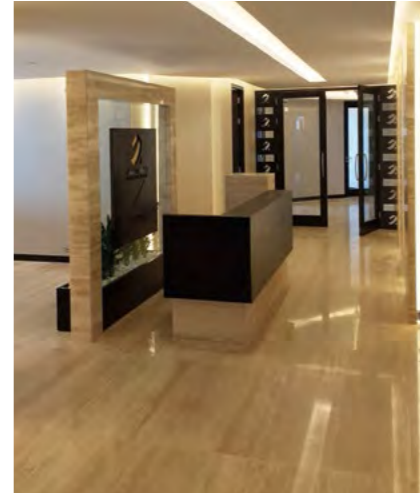

---

The Aerospace Corporation - El Segundo, California - USA  
Al Muhallab Complex - Kuwait  
The Yas Mall - Abu Dhabi - U.A.E.  
Ministry of Foreign Affairs - Doha - Qatar  
Business Lounge Renfe AVE - Alicante, Chamartin, Gerona, Barcelona - Spain  
Centro De Ferias Inatel - Costa Da Caparica - Portugal  
Ambaixada Da Eslovénia - Lisboa - Portugal  
Stock Exchange Lisbon - Lisbon - Portugal  
Academia Da Força Aérea - Sintra - Portugal  
Parlamento de Andalucía - Spain  
Scottish Court Services - Edimburgh - U. K.  
LG Training Center - Seoul - Korea  
Rijnpoort Building - Arnhem - Netherlands  
Tanatorio Municipal de León - León - Spain  
Tanatorio Sitges - Sitges - Spain  
Tanatorio Vic - Barcelona - Spain  
Tanatorio Ronda de Dalt - Barcelona - Spain  
Tanatorio Vilafranca del Penedés - Vilafranca - Spain  
Tanatorio Sant Gervasi - Barcelona - Spain  
Tanatorio Centelles - Vic - Spain  
Tanatorio de Terrassa - Barcelona - Spain  
Tanatorio Sant Joan Despi - Barcelona - Spain  
Tanatori del Penedés - Spain  
Tanatorio de Viladecans - Barcelona - Spain  
Tanatorio de Zaragoza - Spain  
Tanatorio de Logroño - Spain  
Tanatorio de Valencia - Spain  
Tanatorio Collserola - Barcelona - Spain  
Honda Car Showroom - Dublin - Ireland  
Hyundai Life Project - South Korea  
Hyundai Brances in México  
Videobolaget Harry Productions - Stockholm - Sweden  
Train Station Lounges - Cheshire - U. K.  
Sveriges Television - Stockholm - Sweden  
Quartier 108 - Berlin - Germany  
3 RD Floor - London - U. K.  
Cameron Black - London - U. K.  
The Old Manor - Leicestershire - U. K.  
Museo d'Oriente - Lisbon - Portugal  
Fundación universitaria empresa - Valencia - Spain  
West Cheshire Club - Cheshire - U. K.  
General Minor Works Dept. - Manchester - U. K.  
Tanatorio Vilanova i la Geltrú - Barcelona - Spain  
Tanatorio de Colmenar - Madrid - Spain  
Tanatorio de Sant Cugat - Barcelona - Spain  
Tanatorio Cerdanyola del Vallès - Barcelona - Spain  
Tanatorio Pallejà - Barcelona - Spain  
Funeraria Virgen Blanca - Vitoria - Spain  
Tanatorio Vallirana - Barcelona - Spain  
Tanatori Manlleu - Spain  
Tanatorio de Figueres - Girona - Spain  
Tanatorio Sant Boi - Barcelona - Spain  
Tanatorio de Cubelles - Cunit - Spain  
Tanatorio L'hospitalet Ronda - Barcelona - Spain  
Tanatorio Bages Sud - Spain  
Tanatorio Cartes - Cantabria - Spain

---

Tanatorio Ripollet - Barcelona - Spain  
Tanatori Les Corts - Barcelona - Spain  
Concesionarios Lexus - Doha - Qatar  
Concesionarios Hyundai México  
Concesionarios Hyundai Korea

# Public areas

# Áltima Sancho D'Avila

Barcelona, Spain



**Models:**  
**Euphoria XXI** (bench, table)  
**Glamour** (sofa, armchair)

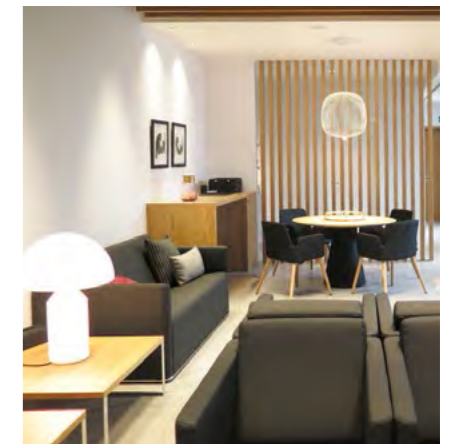



SEC  
Saudi  
Electricity Co.  
Riyadh, Saudi Arabia.

- Models:**  
**Cuc** (sofa)  
**Cayman** (sofa)  
**Kanel** (loung chair)  
**Madalena** (footsool)  
**Wasabi** (coffee table)  
**Riverso** (chair)

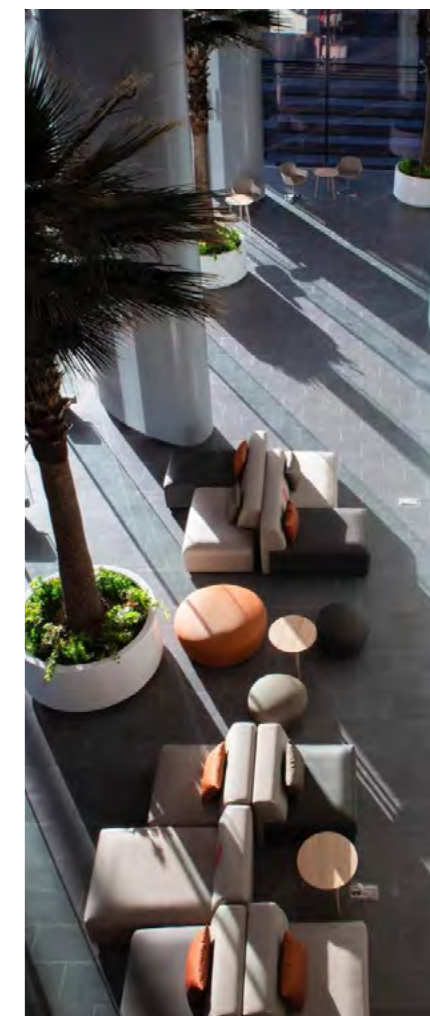
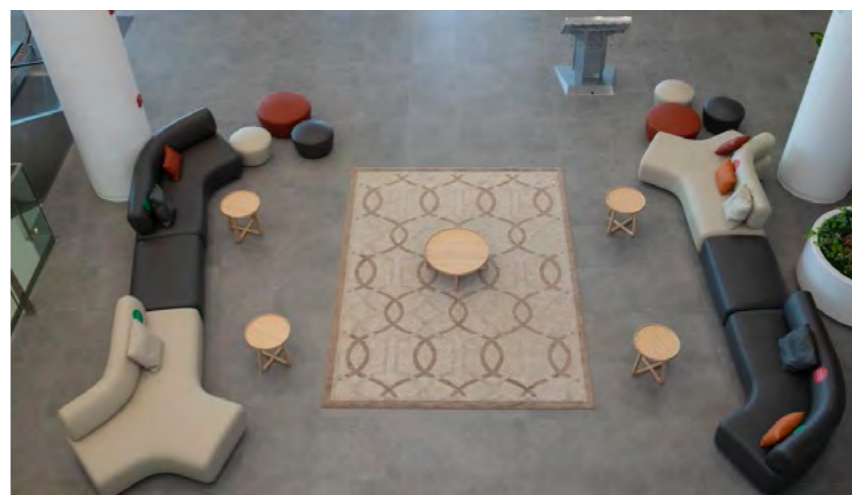



Yas Mall  
The Fashion Avenue,  
Abu Dhabi, U.A.E.

Model:  
Cuc (sofa, bench)

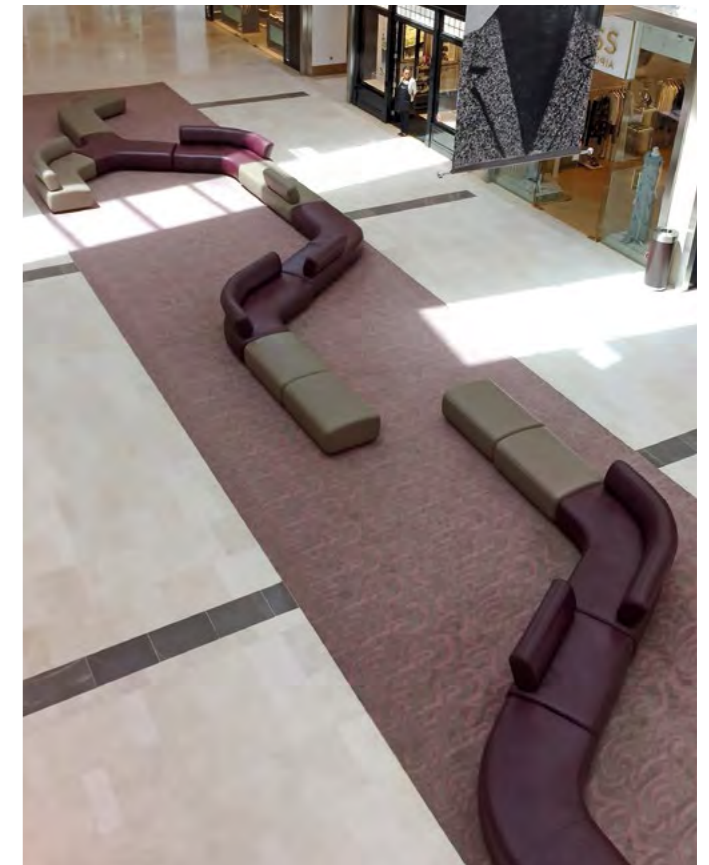

# Magdalena

Funeraria Castellón,  
Spain



Models:  
**Invader** (sofa)  
**Odin Fun** (sofa)

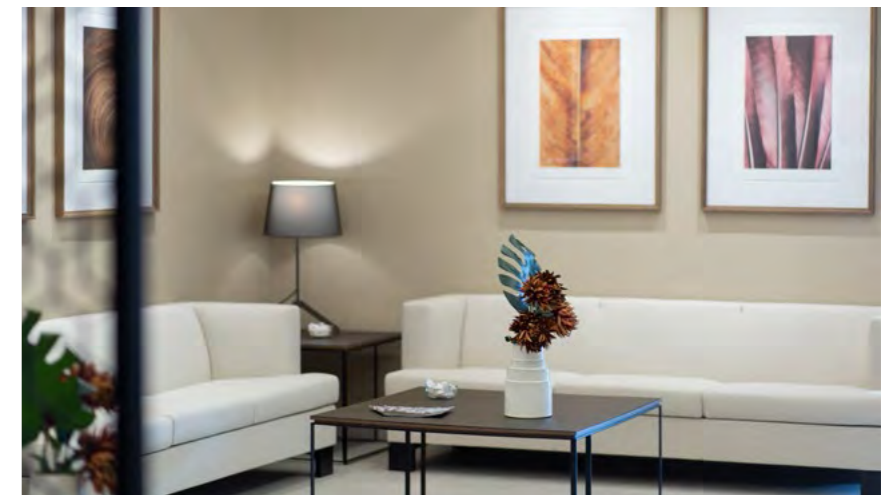

# Áltima

St. Joan Despí Building,  
Spain



Models:  
Euphoria XXI (Bench)  
Glamour (sofa, footstool)

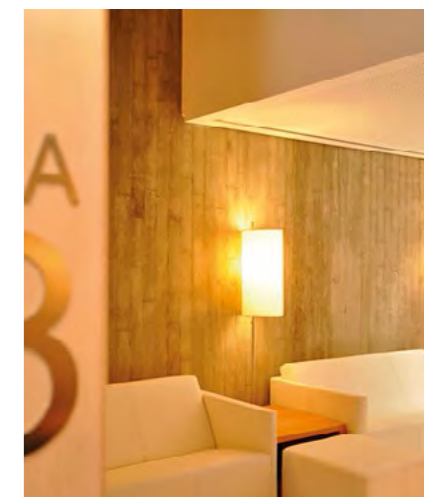

# Áltima

Sitges, Spain



**Models:**  
**Euphoria XXI** (Bench)  
**Interval** (sofa)

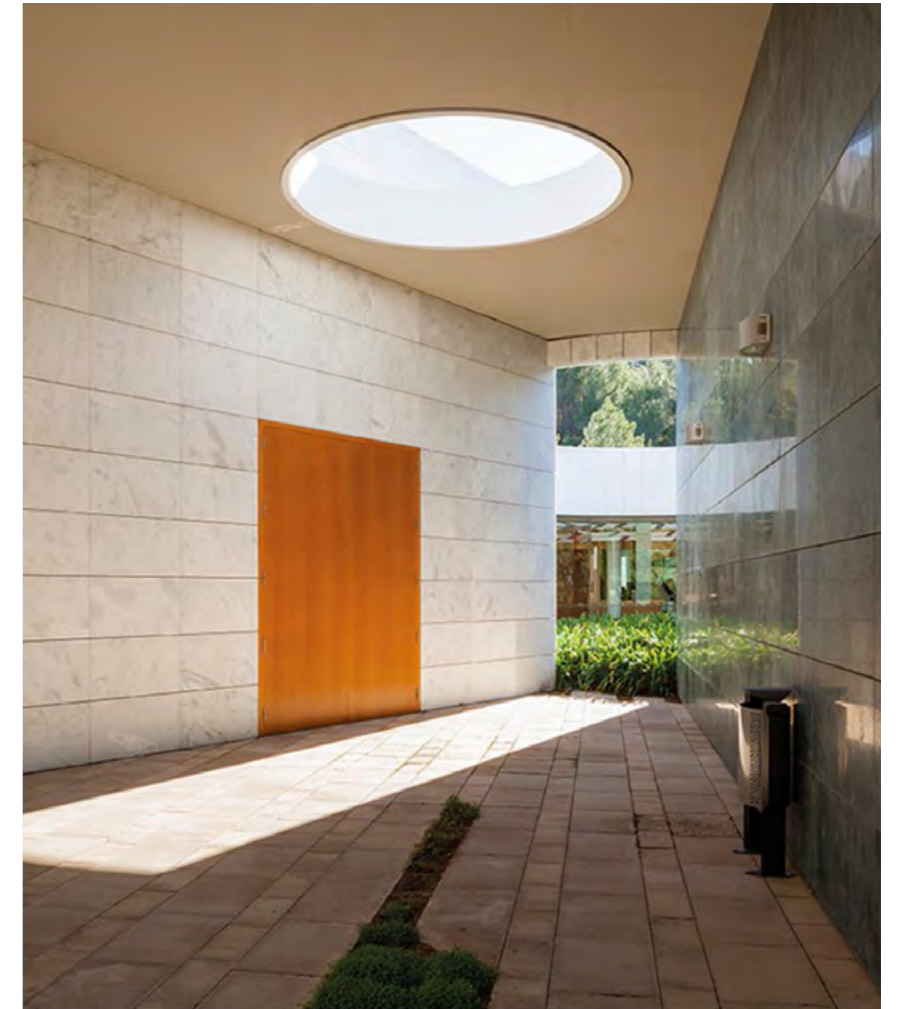





Model:  
Euphoria XXI (sofa, armchair)

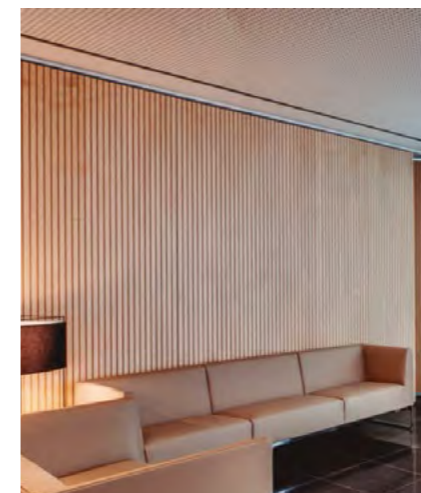

Áltima  
Viladecans, Spain



# Escuela Fama

Madrid, Spain

Model:  
Cuc (sofa)



---

David Lloyd Bournemouth Tennis Club - Bournemouth - U.K.  
David Lloyd Club - Liverpool - U. K.  
David Lloyd Turó Center - Barcelona - Spain  
David Lloyd Leisure Eastbourne - Sussex - U. K.  
Dublin David Lloyd Center - Dublin - Ireland  
David Lloyd Club - Belfast - U. K.  
David Lloyd Marina Leisure - Brighton - U. K.  
David Lloyd Bushey - Bushey - U. K.  
David Lloyd Derby - Derby - U. K.  
David Lloyd Club - Bolton - U. K.  
David Lloyd Hull - Humberside - U. K.  
David Lloyd Enfield - Enfield - U. K.  
David Lloyd Basildon - London - U. K.  
David Lloyd Leisure - London - U. K.  
David Lloyd Heston Tennis Club - Middlesex - U. K.  
David Lloyd Leisure Tennis Club - Milton Keynes - U.K.  
David Lloyd Leisure - Leicester - U. K.  
David Lloyd Solihull - Shirley - Solihull - U. K.  
David Lloyd Stockton - Stockton On Tees - U. K.  
Harbour Club Notting Hill - London - U. K.  
Raffles Country Club - Singapore  
Club Tennis Turó - Barcelona - Spain  
Esporta Health & Fitness - Edinburgh - U. K.  
Esporta Offices - Wokingham - U. K.  
Limerick Golf Club - Limerick - Ireland  
Country Club Pasir Ris Resort - Singapore  
Golf Club La Rioja Residencial - La Rioja - Spain  
Club De Golf Sant Cugat - Sant Cugat - Spain  
Club De Golf Leonardo Da Vinci - Sevilla - Spain  
Club de Golf Fontanals - Girona - Spain  
All England Lawn Tennis & Croquet Club - Wimbledon - U.K.  
Singapore Turf Club - Singapore - Singapore  
Holmes Place Health Club - London - U. K.  
Holmes Place Health Club The Plaza Centre - London - U.K.  
Holmes Place - Nottingham - U. K.  
Holmes Place - London - U. K.  
Holmes Place Health Club - Berkshire - U. K.  
Holmes Place Health Club - Middlesex - U. K.  
Holmes Place Health Club - Farnborough Hants - U. K.  
Holmes Place Health Club - Manchester - U. K.  
Tennis Club La Salud - Barcelona - Spain  
Boss Gimasio Masculino - Barcelona - Spain  
Cambridge University Sports Centre - U. K.  
Bein Sports - Doha - Qatar

# Sports Clubs

# David Lloyd Leisure

More than 20 in  
England & Spain



**Models:**

**Berna** (lounge chair)

**Finca Mini** (lounge chair)

**Pullman** (sofa)

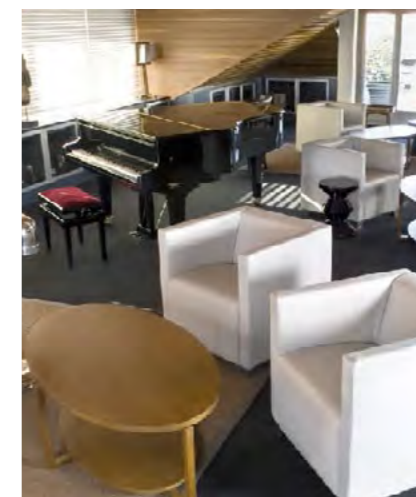
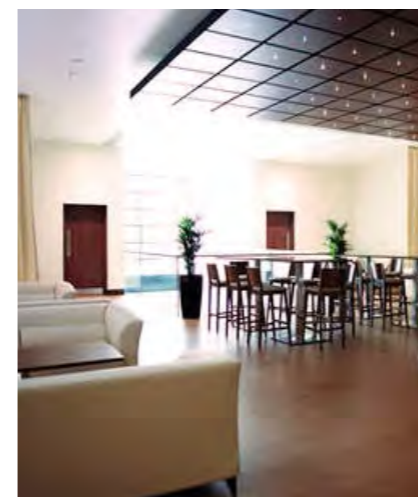

# Turf Club Kranji

Singapore

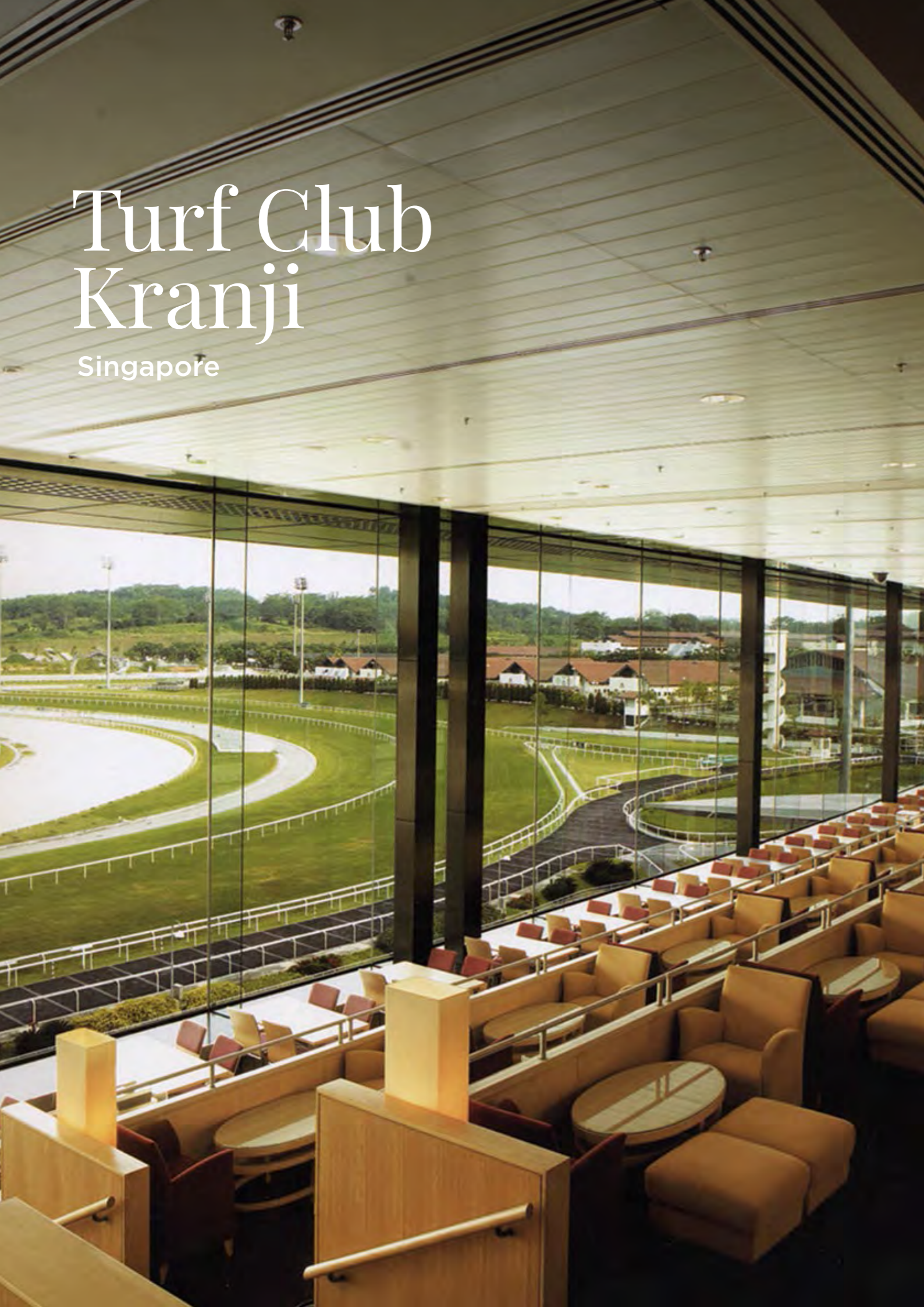

**Model:**  
**Parade** (lounge chair, footstool)



## Institutional

Tribunal Superior de Justicia - México D.F. - México  
Gobierno de Estado de Chiapas Secretaria de Hacienda - México  
Semarnat Dependencia de Gobierno - México  
Ambaixada Da Eslovénia - Lisboa - Portugal  
KCCI Kuwait Chambers of Commerce & Industry - Kuwait  
Ministry of Foreign Affairs - Doha - Qatar  
Scottish Court Services - Edinburgh - UK  
General Minor Works Dept. - Manchester - UK  
Parlamento de Andalucía - Sevilla - Spain

## Educational

New York University - Abu Dahbi - U.A.E  
TBTC University School - Riyadh - Saudi Arabia  
Universidad De Vitoria - Vitoria - Spain  
The University Centre - Cambridge - UK  
Fundació Universitat Empresa - Valencia - Spain  
Esade Creapolis - Sant Cugat - Spain  
Case Western Reserve University - Cleveland, Ohio - United States  
Surrey Sports Park University Of Surrey - Guildford - United Kingdom  
Loyola College - Baltimore - United States  
Cambridge University Sports Centre - UK  
ISM International School Of Management - Frankfurt - Germany  
ISM International School Of Management - Köln - Germany  
IESE Business School - Barcelona - Spain

## Luxury Residential

United States  
United Kingdom  
Saudi Arabia  
United Arab Emirates  
Spain  
México  
France  
Sweden  
Andorra  
Germany  
Netherlands  
Oman  
Singapore  
Iceland  
Switzerland  
Denmark  
Qatar  
Kuwait  
Libanon  
Ireland  
Canada  
Belgium  
Greece  
Austria  
Portugal  
Norway  
Republica Dominicana  
Egypt

# Institutional Educational Luxury Residential



---

Hard Rock Hotel Megapolis - Panama City - Panama  
White Island Resort & Spa - Ibiza - Spain  
Hilton Hotel - Abu Dhabi - U.A.E.  
W Hotel - Mexico D.F. - Mexico  
Arc En Ciel Hotel - El Khroub - Algeria  
Hotel Noelia - Tenerife - Spain  
Be Live Lanzarote Resort - Lanzarote - Spain  
Zapaterías Rusia  
Saudi Private Aviation - Saudi Arabia  
Nexus Suites Hotel - Valladolid - Spain  
Nuffield Health - U.K.  
Hosp. de la Universidad de los Andes - Santiago de Chile  
AC Hotels - Spain  
Hotel Dunes - Doha - Qatar  
Palmira Hotel - Ibiza - Spain  
Google Offices - Dublin - Ireland  
Fiesta Americana - Cozumel - México  
Camino Real Hotel - Puebla - México  
Nima Bay Hotel - Puerto Vallarta - México  
Iberostar Hotels - Spain

# Customized



# Leven Hotel

Manchester, England

Model:  
Customized (sofa, headboard)

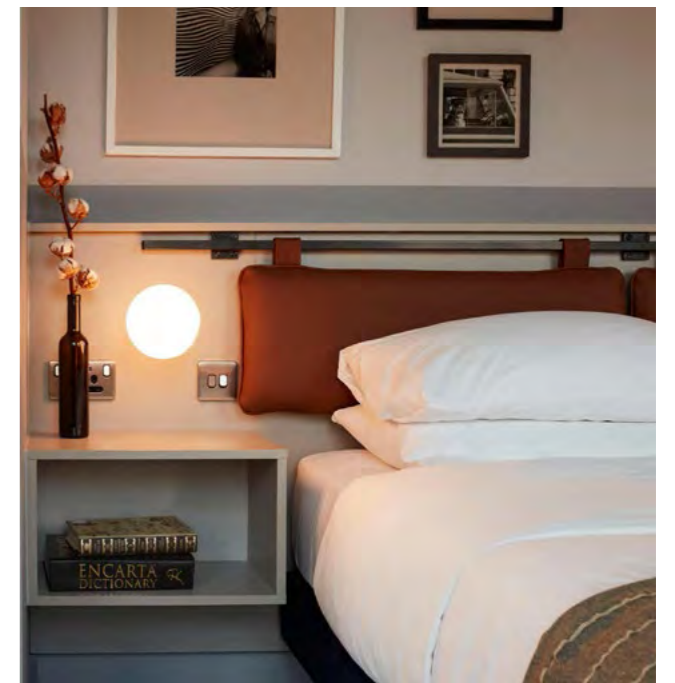



# Hard Rock Hotel

Megapolis, Panamá



**Models:**  
**Customized** (sofa, armchair,  
lounge chair, bench, footstool)

**Models:**

**Customized** (sofa, armchair, lounge chair, bench, footstool)



# W Hotel

Barcelona, Spain.



**Models:**  
**Customized** (sofa, armchair, beds, bench)

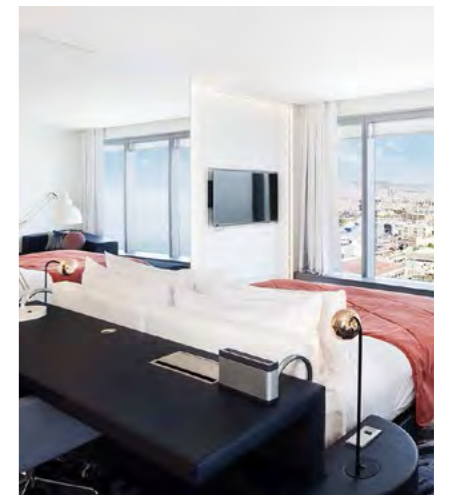
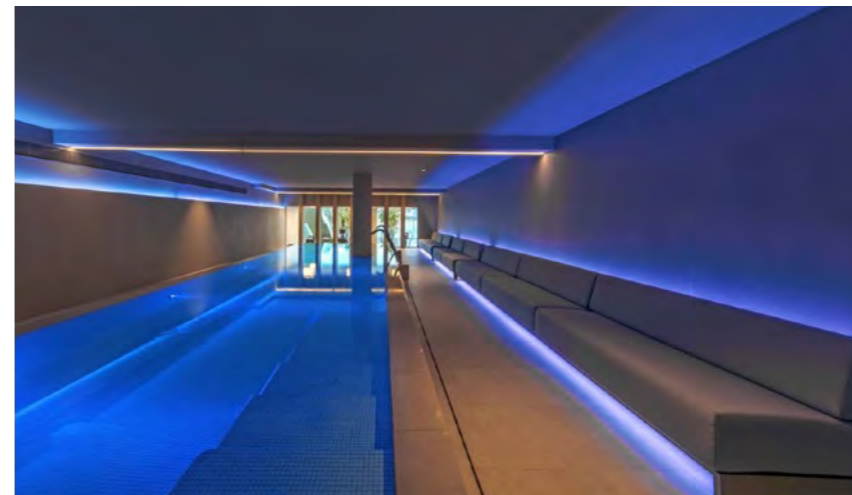



W Hotel  
México D.F.

Models:  
Customized  
(sofa, bed, footstool, table)  
Rosetta (lounge chair)



**Models:**  
**Customized**  
(sofa, bed, footstool, table)  
**Rosetta** (lounge chair)



# Products





## ARTEMIS

José Gras

**EN** · Solid wood frame, 35 Kg. polyether seat and 30 Kg. polyether back. Fix upholstered.

**ES** · Estructura madera maciza, asiento poliéter 35 Kg. y respaldo poliéter 30 Kg. Tapizado fijo.

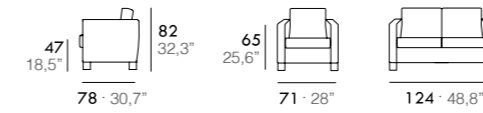





## BERLIN

José Gras

**EN** • Solid wood frame. 35 Kg/m<sup>3</sup> polyether seat. 35 Kg/m<sup>3</sup> polyether back. Fix upholstery.

**ES** • Estructura madera maciza. Asiento poliéter 35 Kg/m<sup>3</sup>. Respaldo poliéter 35 Kg/m<sup>3</sup>. Tapizado fijo.

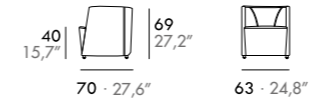





## BERNA · BERNA MADERA

José Gras

**EN** · Solid wood frame, 35 Kg. polyether seat and 35 Kg. polyether back. Fix upholstered..

**ES** · Estructura madera maciza, asiento poliéter 35 Kg. y respaldo poliéter 35 Kg. Tapizado fijo.

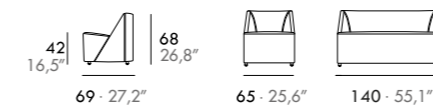



## BON BON

Victoria Alegri

**EN** · Structure: solid steel with a smooth matte epoxy powder paint finish. Top: polished beveled marble.

**ES** · Estructura: acero macizo acabado pintura en polvo epoxy liso mate. Sobre: Mármol biselado pulido.

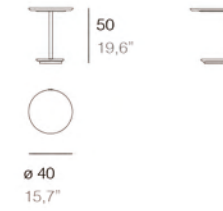





# BOY

José Gras

**EN** • Solid wood covered by polyether. Interlaced elastic webbing. Seat in 30 Kg/m<sup>3</sup> high resilience polyether (CFC free). Back in a combination of 60% antiallergic hollow fibre and 40% down feather. Arm in 100% microfiber cushions. Feet in beechwood varnished in natural and walnut, or metallic feet chromed black finish. Fixed upholstery structure and completely removable cover in the cushions. When it is upholstered in leather it is fixed.

**ES** • Madera maciza recubierta de poliéter y guata acrílica. Cinchas elásticas entrelazadas. Asiento de poliéter de 30 kg/m<sup>3</sup> (sin cfc.) recubierto de guata acrílica. Respaldo de combinación de 60% de fibra antialérgica y 40% de pluma de ave acuática. Sobrebrazos cojines 100% fibra antialérgica. Pies de madera de haya barnizada en colores natural y nogal, o pie metálico acabado cromo negro. Estructura tapizado fijo, cojines desenfundables.

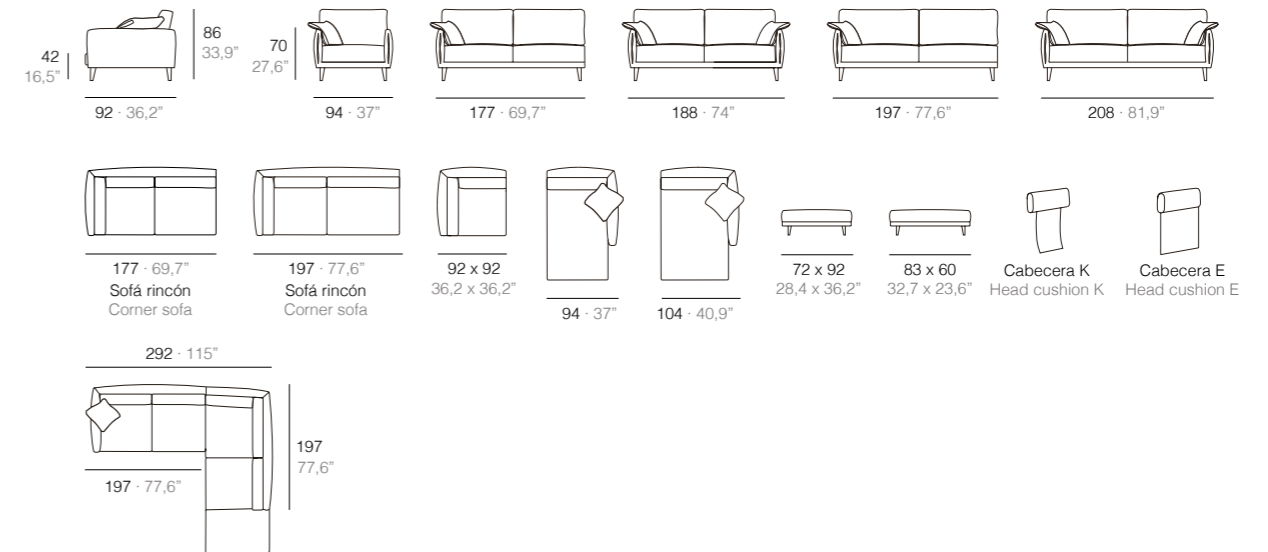





## CALA D'OR · CALAS

Grassoler Studio

**EN** · Solid wood frame covered by polyether and 300 gr acrylic padding. Suspension with "Nosag" metallic springs. Seat in 30 kg/m<sup>3</sup> polyether (cfc free). Back in 28 kgs/m<sup>3</sup> super soft polyether (cfc free). Black nylon feet. Completely removable cover. Optional: kidney cushion in 23 kg/m<sup>3</sup> polyether, covered with acrylic padding. Headcushion in 25 kg/m<sup>3</sup> microfiber, covered with acrylic padding.

We recommend upholstering Calas - Cala D'or in natural fabrics such as linen or cotton. Other types of fabrics are not suitable.

**ES** · Estructura madera maciza recubierta de poliéter y guata acrílica de 300 gr. Suspensión bastidores nosag. Asiento Poliéter de 30 kg/m<sup>3</sup> (sin cfc). Respaldo poliéter de 28 kg/m<sup>3</sup> super suave (sin cfc). Pies taco de nylon negro. Tapizado totalmente desenfundable. Opcional: riñonera de poliéter de 23 kg/m<sup>3</sup>, recubierta de guata acrílica. Cojín cabecal relleno de microfibra con soporte de poliéter de 25 Kg/m<sup>3</sup> recubierto de guata acrílica.

Calas - Cala D'or es ideal para tapizar en telas naturales tipo lino o algodón. No se recomienda otro tipo de telas.

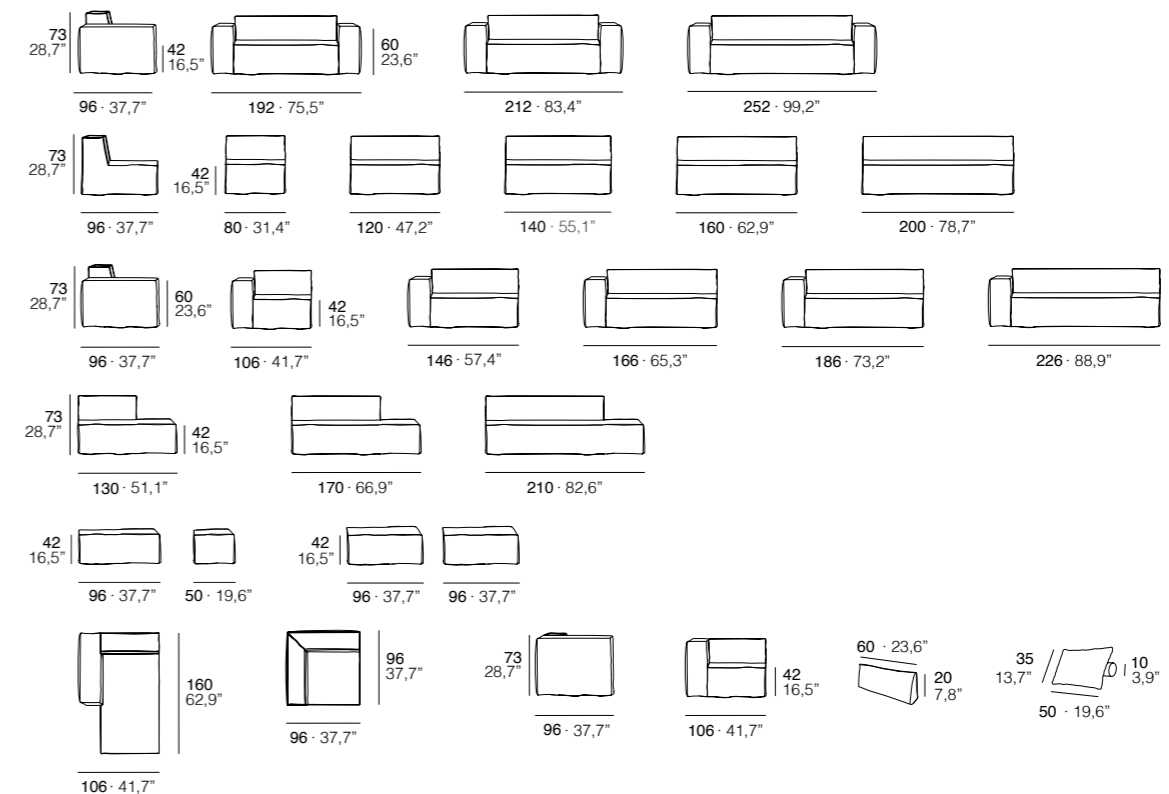

CALA D'OR



CALAS









# CAYMAN

Grassoler Studio

**EN** · Solid wood frame, 30 Kg/m<sup>3</sup> polyether seat and 25 Kg/m<sup>3</sup> polyether back. Fix upholstered.

**ES** · Estructura de madera maciza, asiento poliéter 30 Kg/m<sup>3</sup> y respaldo poliéter 25 Kg/m<sup>3</sup>. Tapizado fijo.

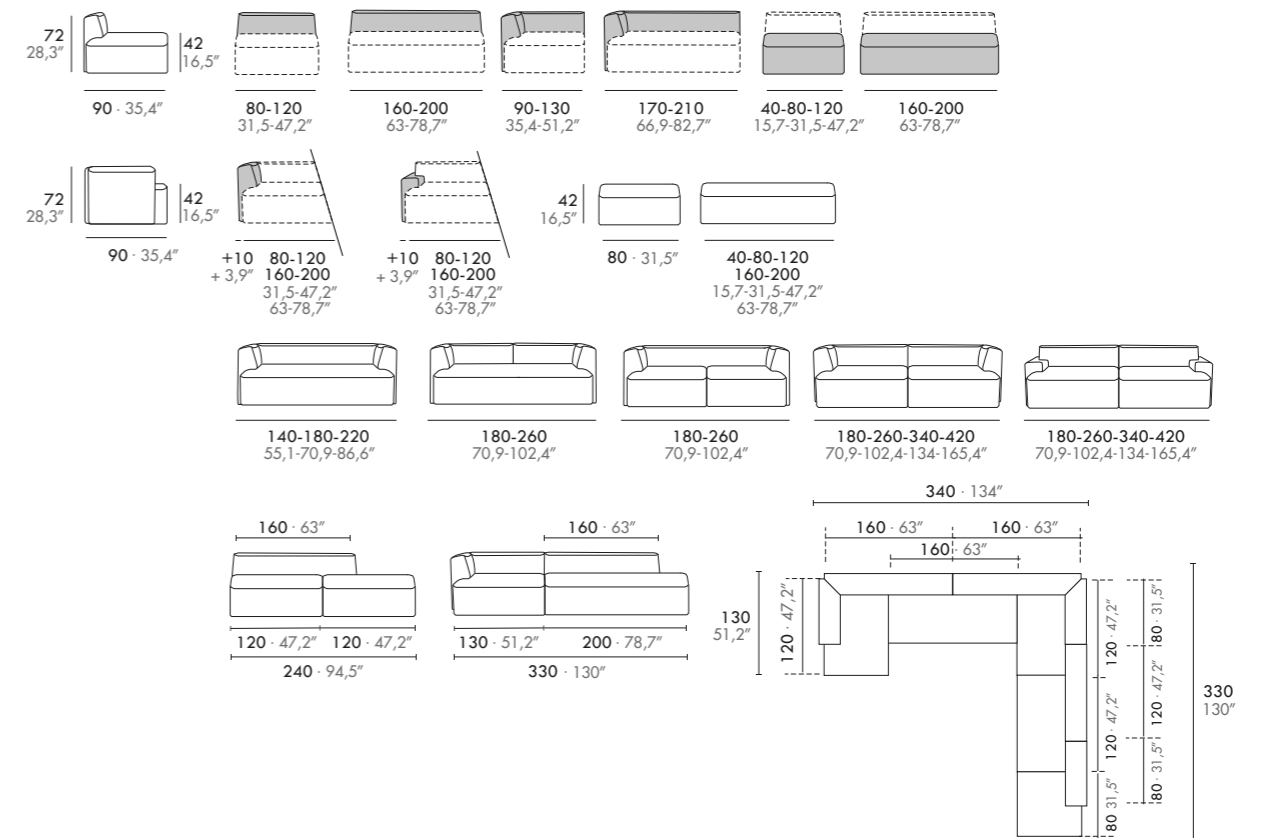

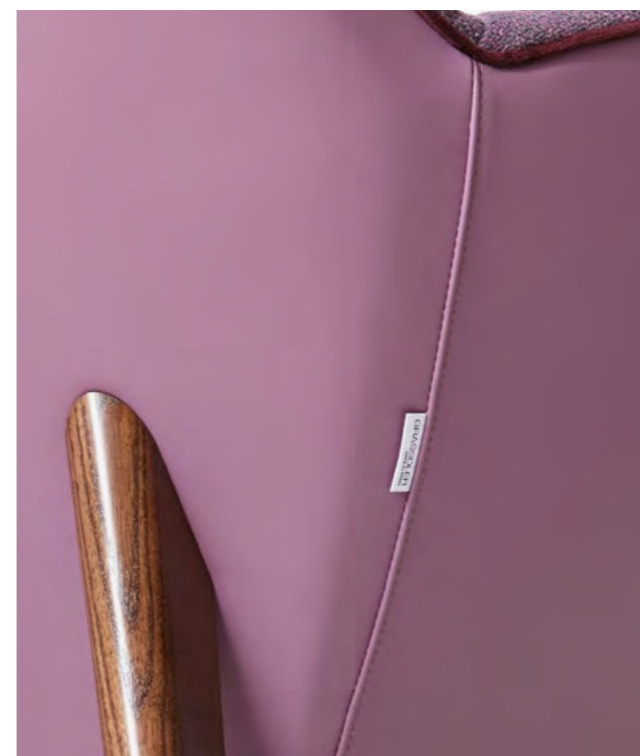
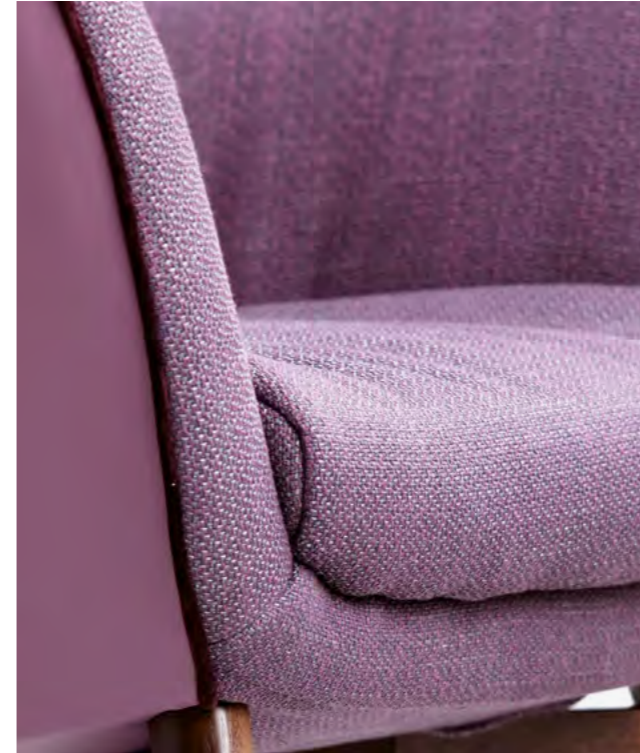



## CHARME · CHARME MIX

Grassoler Studio

**EN** · Cold moulded foam module over metallic frame. Swivel only with metallic base option. Fix upholstery.

**ES** · Espuma de poliuretano moldeado en frío sobre estructura de acero. Base giratoria sólo con la opción metálica. Tapizado fijo.

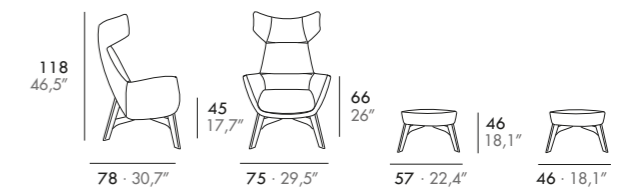
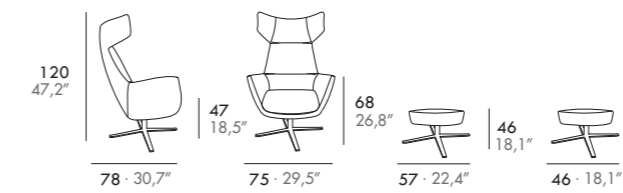



## CLIP

Equipo Diseño Masis

**EN** • Structure: polished steel tube, with different finishes. Top: MDF veneered with natural wood veneers or special lacquered melamine MDF. Optional: drawer with complete extraction guides without brake. Or no drawer.

**ES** • Estructura: Tubo de acero pulido, con diferentes acabados. Sobre: MDF chapado con chapas de madera natural o MDF melamínico especial para lacar. Opcional: Cajón mediante guías de extracción completa sin freno. O sin cajón.

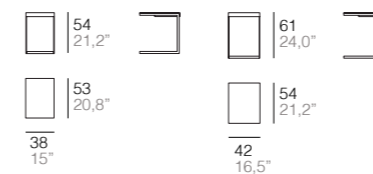



# CUBIC

Equipo Diseño Masis

**EN** · Structure: polished steel tube with a liquid lacquer, epoxy or polished chrome finish. Top / magazine rack: MDF board with a natural veneer finish or special melamine MDF board for lacquer. Transparent, gloss or matt lacquered glass and gray laminated glass.

**ES** · Estructura: Tubo de acero pulido acabado pintura líquida laca, epoxy o cromo pulido. Sobre / revistero: Tablero MDF acabado chapa natural o tablero MDF melamínico especial para laca. Vidrios transparentes, lacados brillo o mate y vidrio lamiado gris.

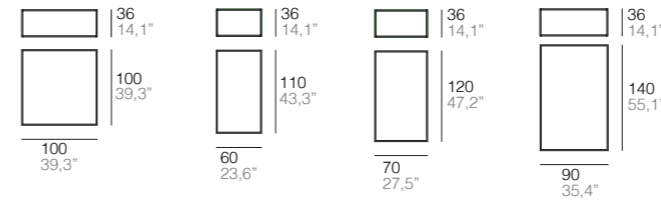

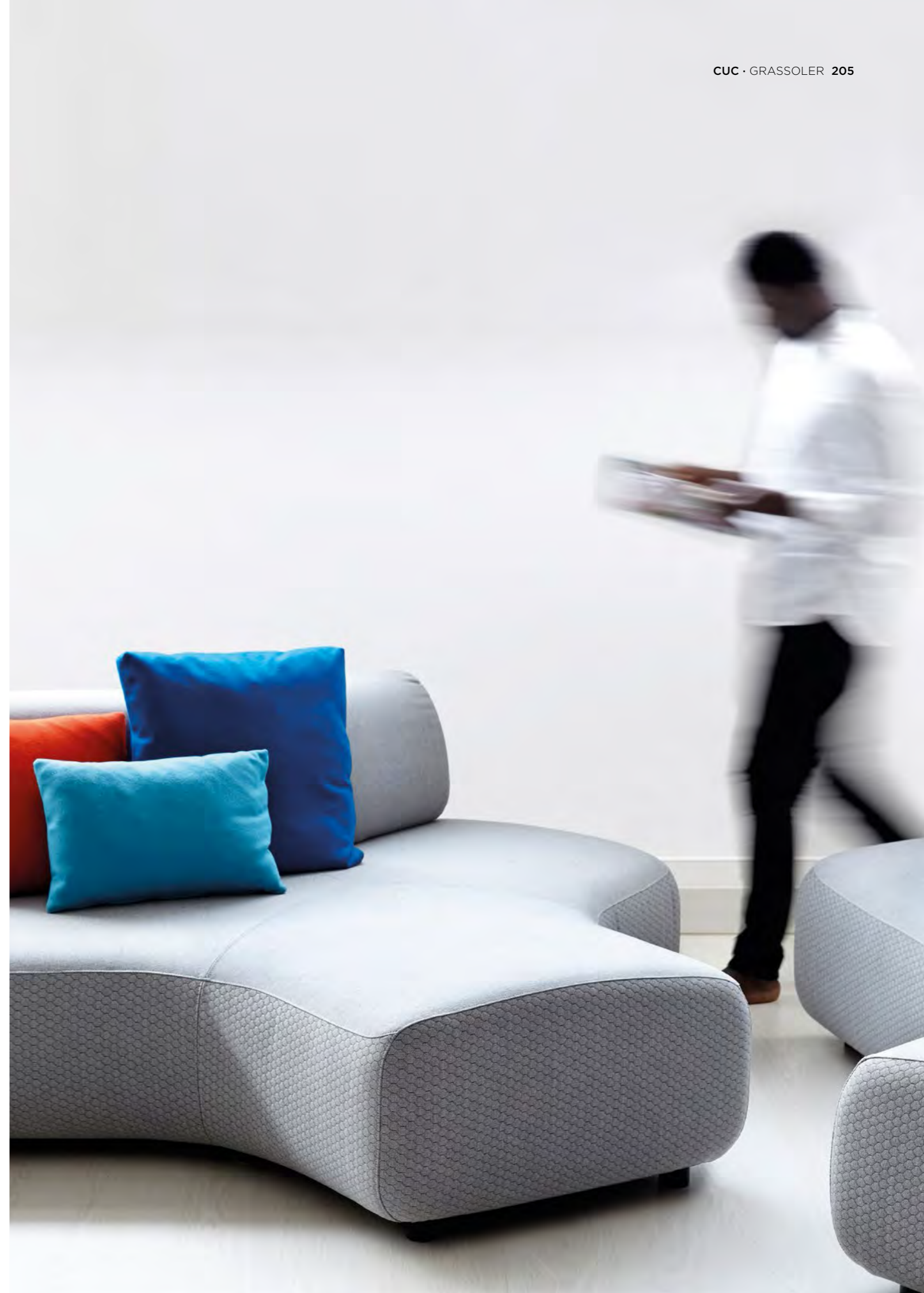



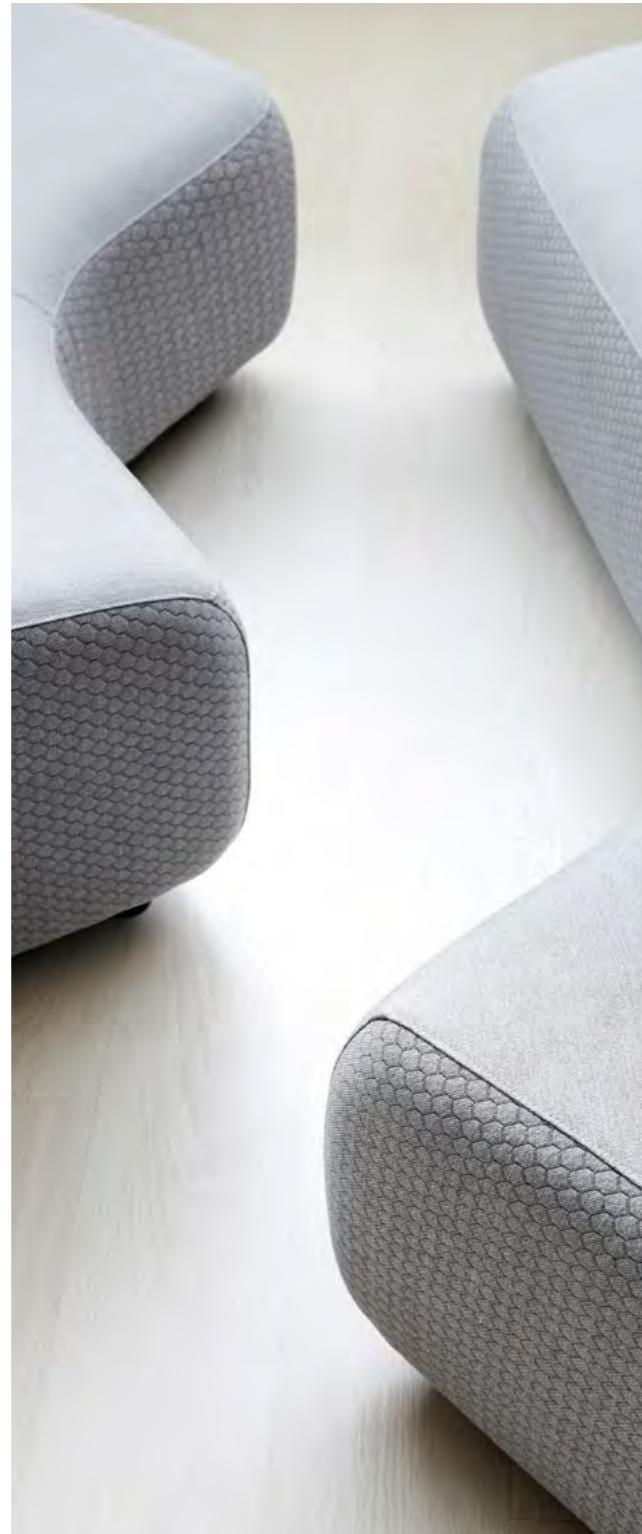

# CUC

Gabriel Teixidó

**EN** · Solid wood frame, 35 Kg/m<sup>3</sup> polyether seat and 35 Kg/m<sup>3</sup> polyether back. Back: metal inner frame. Fix upholstered.

**ES** · Estructura de madera maciza, asiento poliéter 35 Kg/m<sup>3</sup> y respaldo poliéter 35 Kg/m<sup>3</sup>. La estructura del cabezal es metálica. Tapizado fijo.

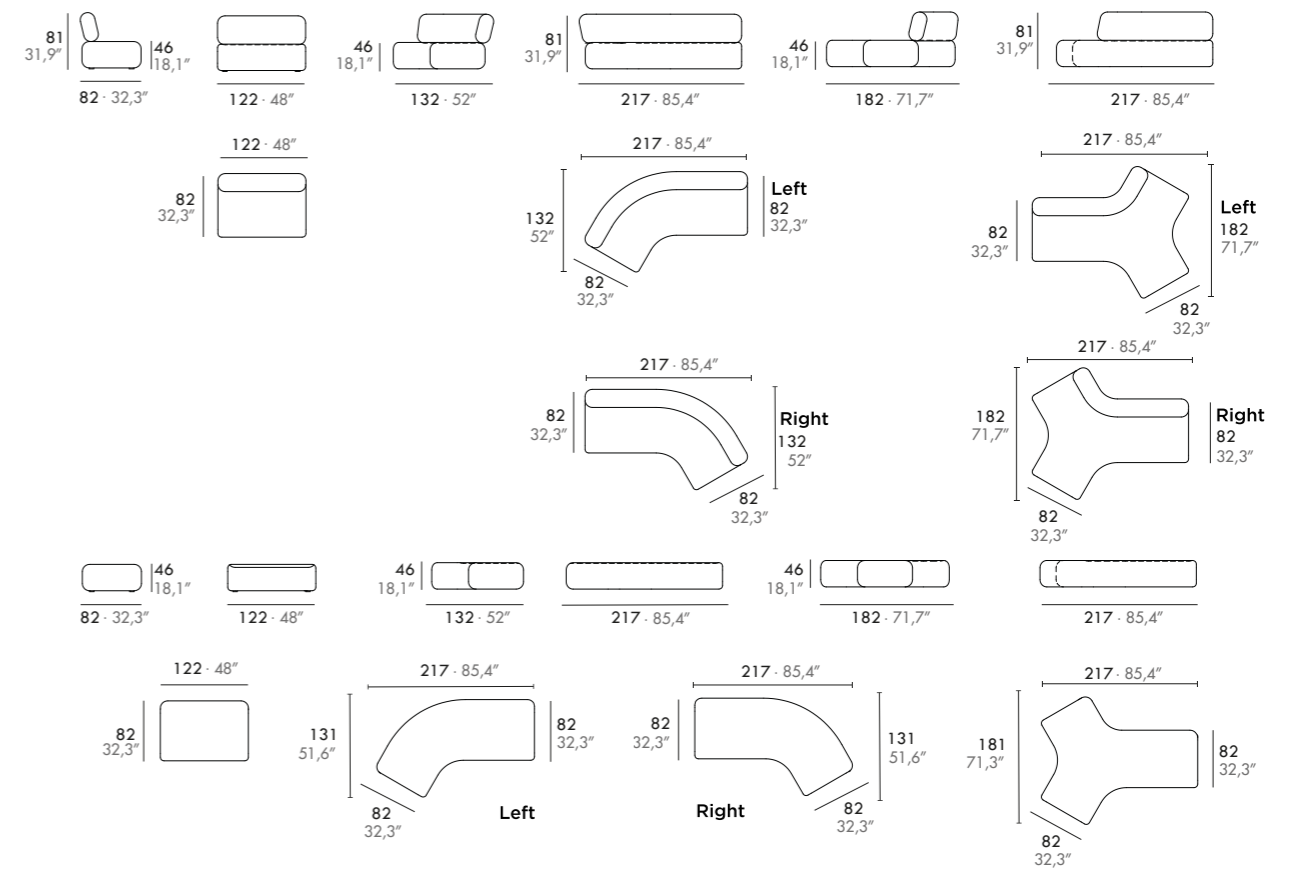





# DAKOTA

José Gras

**EN** · Metallic frame, knock down arms. Suspension by metallic springs, comfort to choose: soft, middle or firm. Two seat inclinations. Seat in "Viscoelastic" 55 Kg/m<sup>3</sup> "memory effect" foam, fiber back cushions. Completely removable covers.

**ES** · Estructura metálica, brazos desmontables. Suspensión mediante muelles, confort a elegir: suave, medio y firme. Dos inclinaciones de asiento. Asiento viscoelástico 55Kg/m<sup>3</sup> poliéster extraconfort "efecto retorno". Respaldo de fibra. Totalmente desenfundable.

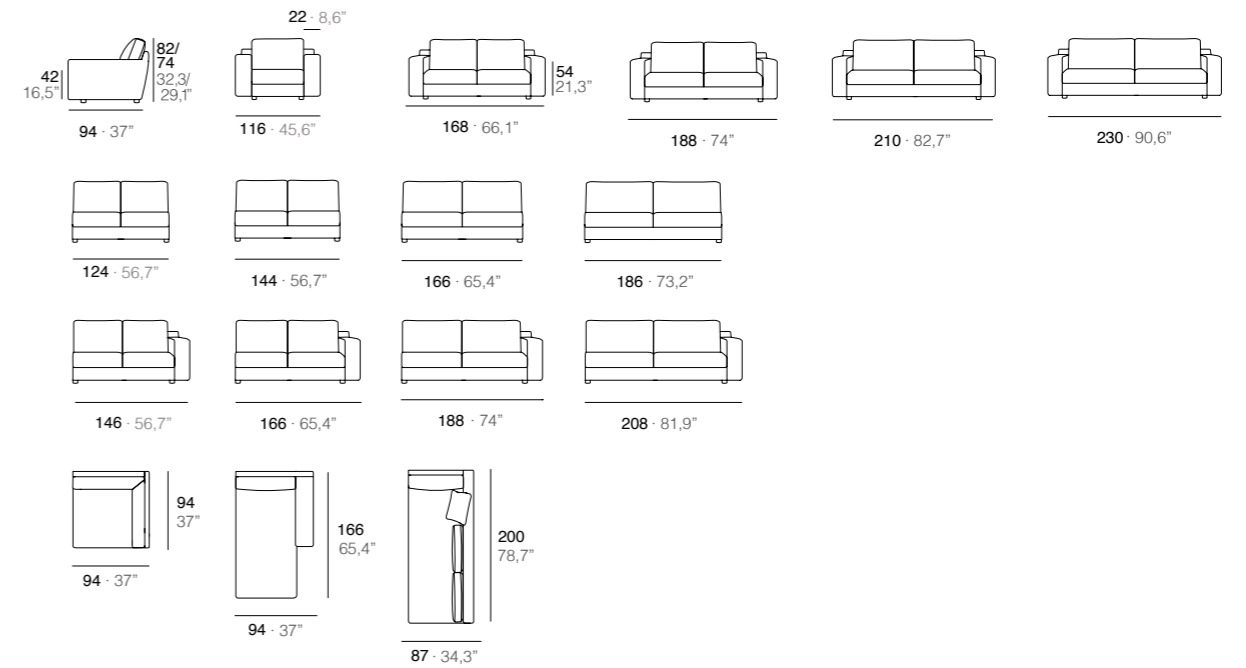





# DARIS

José Gras

**EN** • Metallic frame, knock down arms, suspension by metallic springs comfort to choose: soft, middle or firm. Two seat inclinations, Seat cushion 35 kgs/m<sup>3</sup> polyether extra comfort on base + 30 Kg/m<sup>3</sup> soft polieter on top. With wrinkle control. Back TRDBF - 100% antiallergic hollow fiber. Completely removable covers.

**ES** • Estructura metálica, brazos desmontables, suspensión mediante muelles confort a elegir: suave, medio y firme. Dos inclinaciones de asiento. Cojín asiento base de poliéter 35Kg/m<sup>3</sup> extraconfort + poliéter de 30Kg/m<sup>3</sup> suave en la parte superior, respaldo en TRDBF- 100% fibra antialérgica. Totalmente desenfundable.

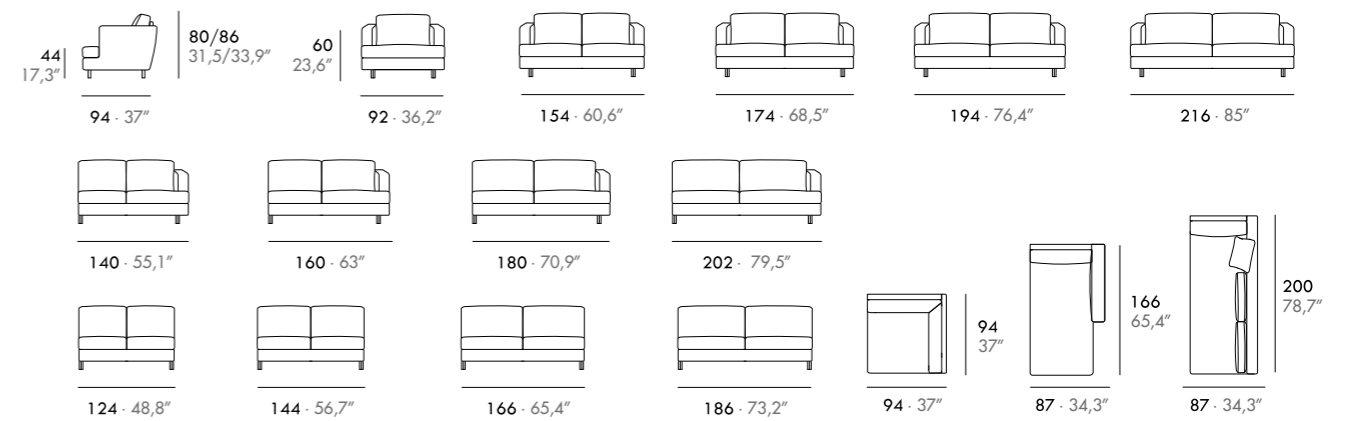



## DEEP 87

Yoshiaru Hatano

**EN** • Solid wood covered by polyether. Interlaced elastic webbing. Seat in 35 Kg/m<sup>3</sup> high resilience polyether (CFC free). Back in 100% antiallergic hollow fiber. Metallic feet painted in brown. Completely removable cover. Loose covers separated into parts for an easy washing. When it is upholstered in leather it is fixed.

**ES** • Madera maciza recubierta de poliéter. Cinchas elásticas entrelazadas. Asiento cojín de poliéter de 35 Kg/m<sup>3</sup> (sin cfc). Respaldo 100% de fibra antialérgica. Pies metálicos pintados en marrón. Estructura tapizado fijo, cojines desenfundables.

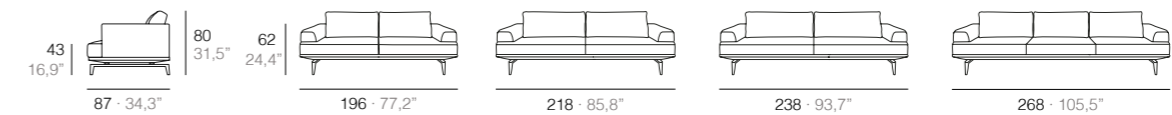





# DEFINY

José Gras

**EN** · Metallic frame, knock down arms. Suspension by metallic springs, comfort to choose: soft, middle or firm. Two seat inclinations. Seat in "Viscoelastic" 55 Kg/m<sup>3</sup> "memory effect" foam, fiber back cushions. Completely removable covers.

**ES** · Estructura metálica, brazos desmontables. Suspensión mediante muelles, confort a elegir: suave, medio y firme. Dos inclinaciones de asiento. Asiento viscoelástico 55Kg/m<sup>3</sup> poliéter extraconfort "efecto retorno". Respaldo de fibra. Totalmente desenfundable.

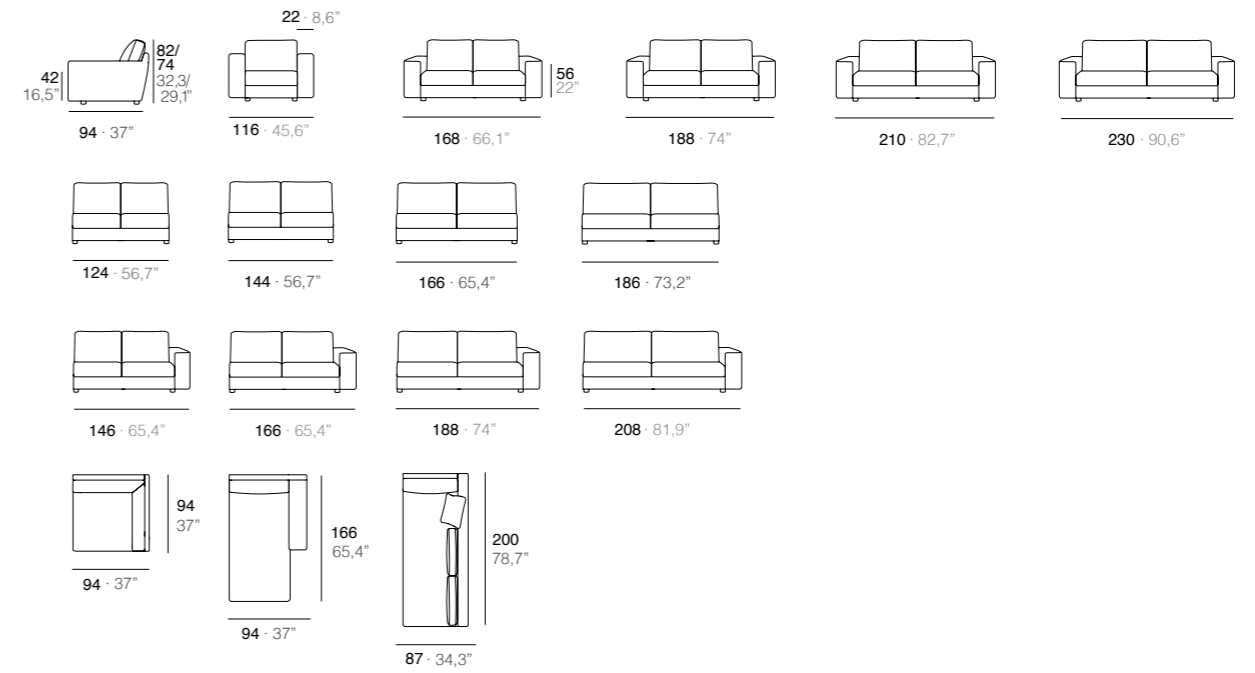





# DURBAN

José Gras

**EN** · Metallic frame, knock down arms. Suspension by metallic springs, comfort to choose: soft, middle or firm. Two seat inclinations. Seat in "Viscoelastic" 50 Kg/m<sup>3</sup> "memory effect" foam. 70% antiallergic hollow fiber and 30% feather back cushions. Completely removable covers.

**ES** · Estructura metálica, brazos desmontables. Suspensión mediante muelles, confort a elegir: suave, medio y firme. Dos inclinaciones de asiento. Asiento viscoelástico 50Kg/m<sup>3</sup> poliéter extraconfort "efecto retorno". Respaldo 70% fibra antialérgica y 30% pluma de ave acuática. Totalmente desenfundable.

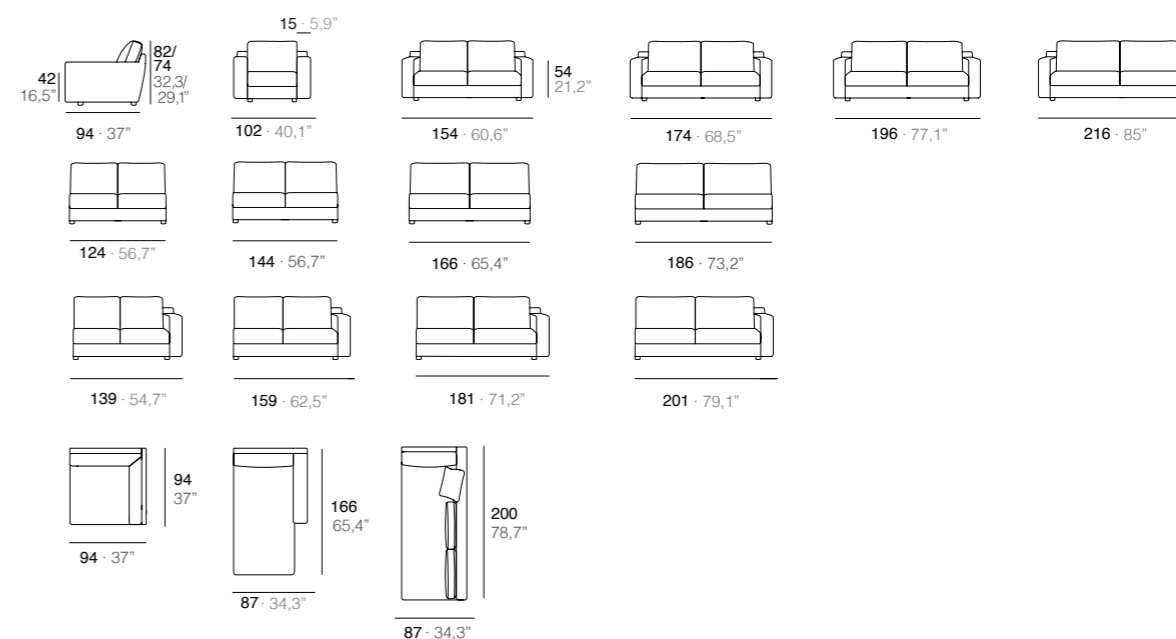





## ELDER

Gabriel Teixidó

**EN** · Solid wood frame, 35 Kg. polyether seat and 35 Kg. polyether back, aluminium feet or painted. Fix upholstered.

**ES** · Estructura madera maciza, asiento poliéter 35 Kg. respaldo poliéter 35 Kg, pies aluminio o pintados. Tapizado fijo.

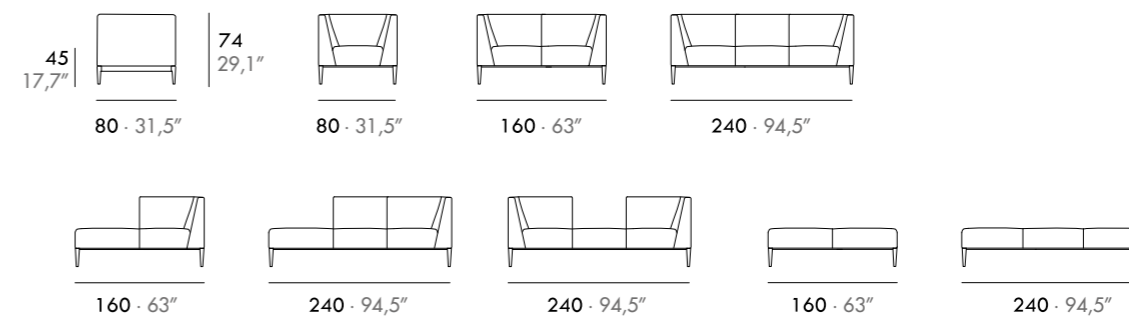



## ELDER VINTAGE

Grassoler Studio

**EN** • Solid wood frame covered by polyether, removable structure. Interlaced elastic webbing. 35 Kg polyether Seat. 25 Kg/m<sup>3</sup> polyether Cushions. Back in 35 Kg Polyether. Beech wood feet varnished in Wenge 492. Optional feet/base varnished in beech wood Natural 401, Oak 426 or Walnut G01. Fixed upholstery.

**ES** • Estructura madera maciza recubierta de poliéter. Estructura desmontable. Suspensión cinchas elásticas entrelazadas. Asiento poliéter de 35 Kg/m<sup>3</sup>. Cojines rulo en poliéter de 25 Kg/m<sup>3</sup>. Respaldo poliéter de 35 Kg. Pies base de madera de haya barnizada color Wengué 492. Opcional base/pies disponibles en haya barnizado Natural 401, Nogal G01 o Roble 426. Tapizado tapizado fijo.

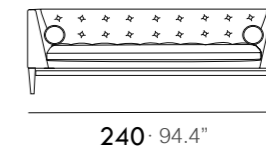
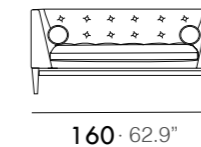
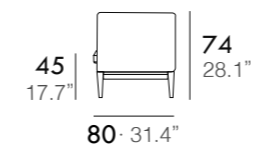





## EUDOS · EUDOS PASTILLAS

José Gras

**EN** · Cold laminate steel frame combined with solid wood covered by polyether; removable structure painted in brown or aluminium colour. "Nosag" metallic springs suspension. 35 Kg polyether seat 30/40 Kg polyether back. Removable polished aluminium feet with antisliding rubber caps. Height: 16 cm. or 22 cm. Optional feet painted in RAL colour. Padded finishing with stitches on the seat, lateral piping on back, arms with piping on the side. Fixed upholstered,

**ES** · Estructura acero laminado frío combinado con madera maciza recubierta de poliéter. Estructura desmontable. Base metálica de acero laminado, pintada marrón o Aluminio. Suspensión bastidor de muelles metálicos "Nosag". Asiento en poliéter de 35 Kg. Respaldo poliéter de 30/40 Kg. Pies de aluminio pulido de fundición. Con tapón antideslizante de caucho. Pies desmontables. Altura de 16cm o 22cm. Opcional pies pintados en color RAL, con suplemento. Tapizado asiento cosido liso con puntadas en el asiento. Respaldo con pestaña en el lateral. Brazo con pestaña en el frente. Tapizado fijo.

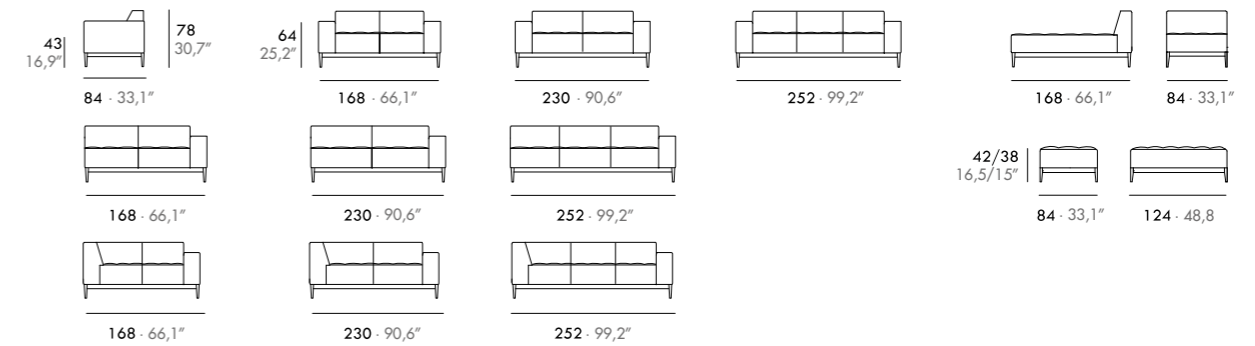



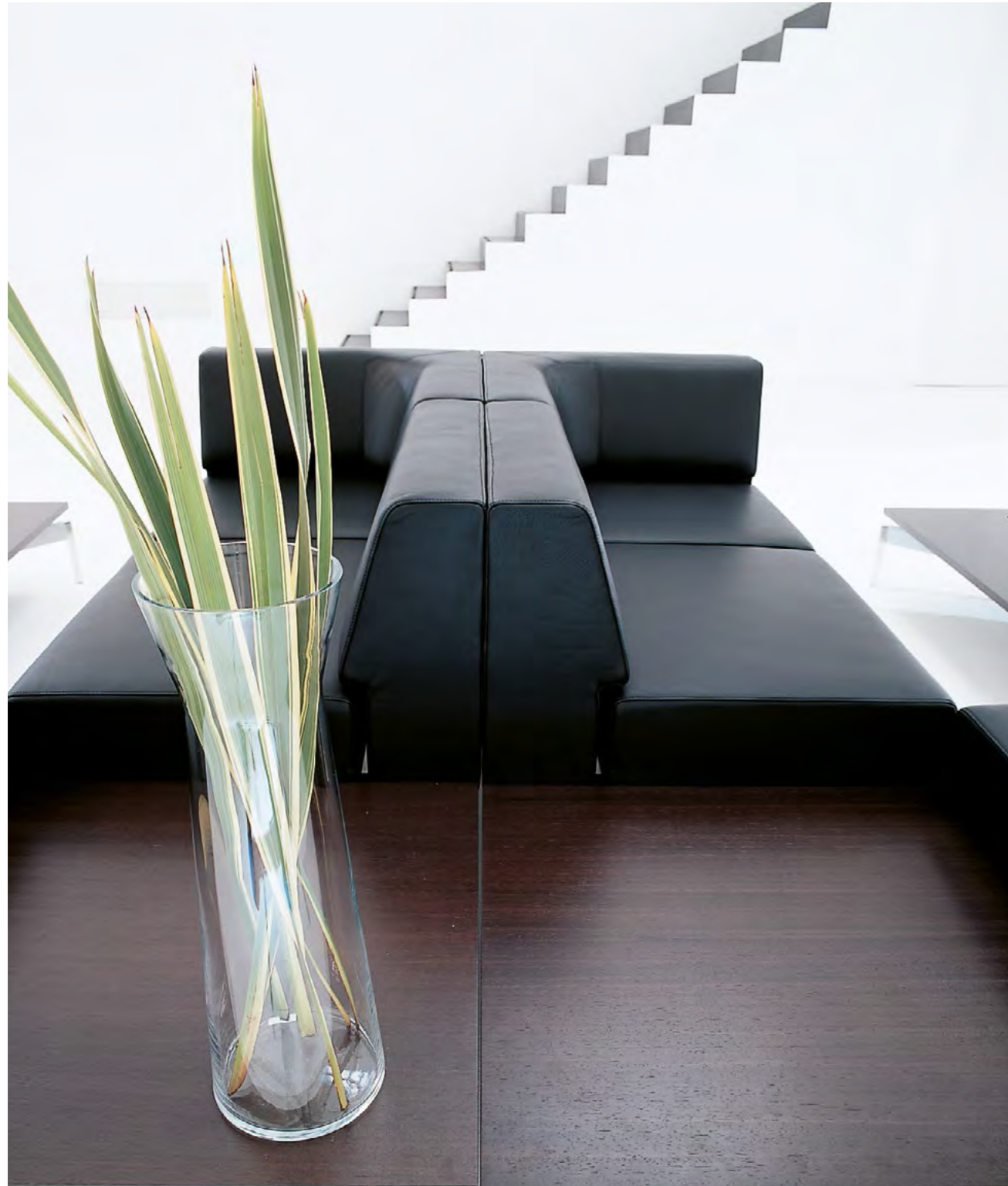





# EUPHORIA XXI

Gabriel Teixidó

**EN** · Steel and solid wood frame, knock-down frame, Nosag springs, 35 Kg. polyether seat and 30/40 Kg. polyether back, aluminium feet. Fix upholstered.

**ES** · Estructura metálica y de madera, desmontable, muelles Nosag, asiento poliéter 35 Kg. y respaldo poliéter 30/40 Kg., pies aluminio. Tapizado fijo.

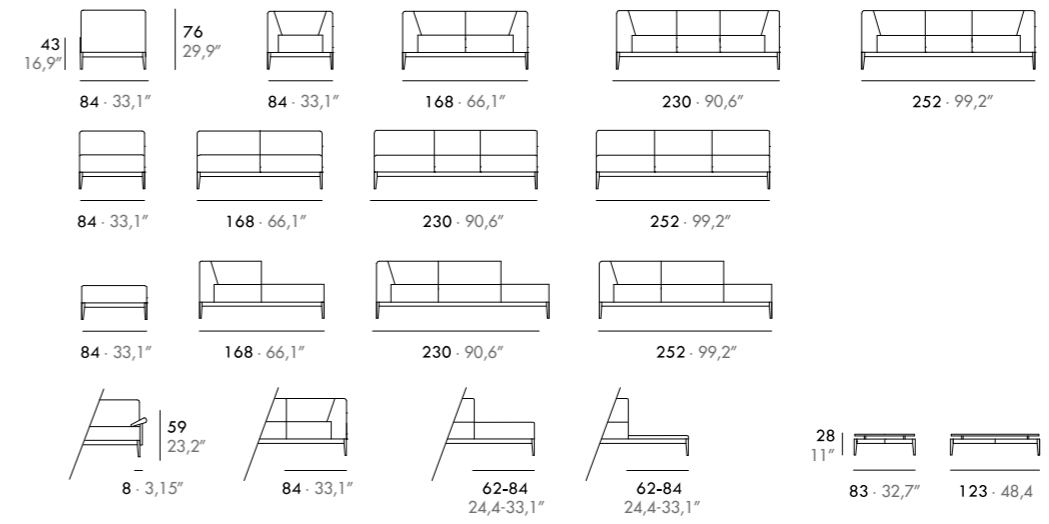





## EVERY

Gabriel Teixidó

**EN** · Solid wood frame, 35 Kg. polyether seat and 35 Kg. polyether back, metalrod chromed or painted in white or painted in white. Fix upholstered.

**ES** · Estructura madera maciza, asiento poliéter 35 Kg. y respaldo poliéter 35 Kg., varilla metálica cromada o pintada blanca. Tapizado fijo.

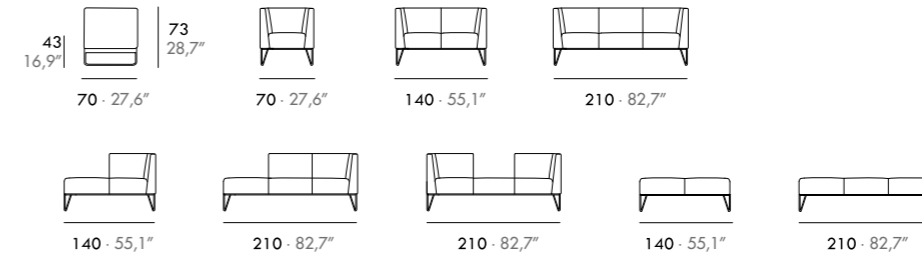



## EVERY MADERA

Grassoler Studio

**EN** · Solid wood frame, 35 Kg. polyether seat and 35 Kg. polyether back, metalrod chromed or painted in white or painted in white. Fix upholstered.

**ES** · Estructura madera maciza recubierta de poliéter. Suspensión cinchas elásticas entrelazadas. Asiento en poliéter de 35 Kg. Respaldo en Poliéter de 35 Kg. Pies base de madera de haya barnizada color Nogal G01. Opcional base disponible en madera de haya barnizada color Natural 401, Roble 426 o Wengué 492, Tapizado fijo.

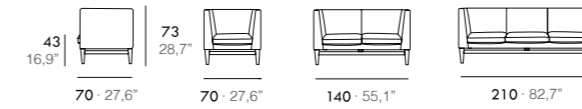



## EVOLVE

Grassoler Studio

**EN** • Cold laminate steel combined with solid wood covered by polyether frame. Removable structure. Metallic laminated steel base, painted in black or aluminium colour. Interlaced elastic webbing suspension. 35 Kg Polyether seat, 35 Kg polyether back, 23 Kg polyether kidney pillow. Metallic and removable feet painted in black or polished aluminium, with an antisliding rubber cap. Black feet has aluminium colour base. Optional: Base/Feet painted in different RAL chard colour. Fixed Upholstery.

**ES** • Estructura de acero laminado frío combinado con madera maciza recubierta de poliéter. Estructura desmontable. Base metálica de acero laminado, pintada en negro o aluminio. Suspensión con cinchas elásticas entrelazadas. Asiento poliéter de 35 Kg/m<sup>3</sup>. Respaldo poliéter de 35 Kg. Riñonera poliéter de 23 Kg. Pies metálicos pintados en negro o de Aluminio pulido de fundición. Con tapón antideslizante de caucho. Pies desmontables. Los pies negros llevan la base en color negro. Los pies pulidos llevan la base pintada en color aluminio. Opcional base/pies pintados color RAL, con suplemento. Tapizado fijo.

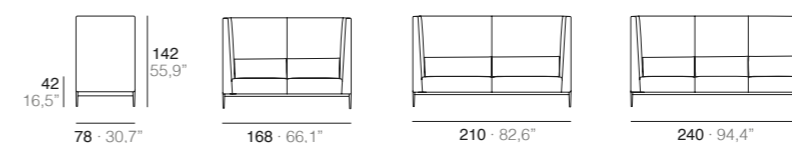



## FINCA MINI

José Gras

**EN** · Solid wood frame, 35 Kg. polyether seat and 30 Kg. polyether back. Fix upholstered.

**ES** · Estructura madera maciza, asiento poliéter 35 Kg. y respaldo poliéter 30 Kg. Tapizado fijo.

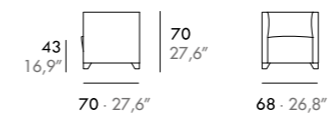



# FIORD

Victoria Alegri

**EN** • Structure: Curved steel plate with a smooth matte epoxy powder paint finish. Top: Polished marble, MDF board veneered with natural wood veneers with a silky varnish finish or special lacquered melamine MDF board with a matte lacquer finish. Magazine rack: MDF board veneered with natural wood veneers with a silky varnish finish or special melamine MDF board for lacquering with a matte lacquer finish.

**ES** • Estructura: Plancha de acero curvado acabado pintura en polvo epoxy liso mate. Sobre: Mármol pulido, tablero MDF chapado con chapas madera natural con acabado barniz sedoso o tablero MDF melamínico especial para lacado con acabado lacados mate. Revistero: Tablero MDF chapado con chapas madera natural con acabado barniz sedoso o tablero MDF melamínico especial para lacado con acabado lacados mate.

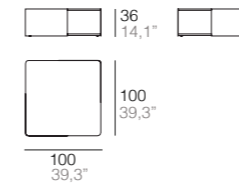







# GLAMOUR

Gabriel Teixidó

**EN** · Solid wood frame, 35 Kg. polyether seat and 30 Kg. polyether back. Fix upholstered.

**ES** · Estructura madera maciza, asiento poliéter 35 Kg. y respaldo poliéter 30 Kg. Tapizado fijo.

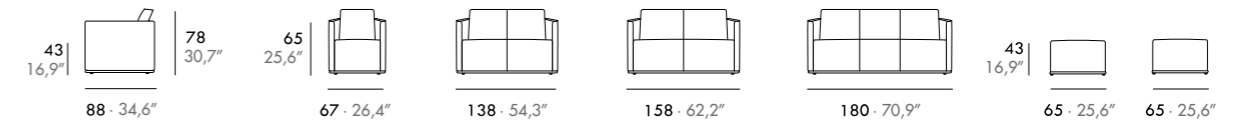



## GLOBAL

José Gras

**EN** · Solid wood frame, seat in 35 Kg. polyether and back cushion in down feather, adjustable headcushion. Fix upholstered.

**ES** · Estructura madera maciza, asiento de poliéter de 35 Kg. y respaldo pluma de ave, cabezal regulable en altura. Tapizado fijo.





## GRAMMY

Gabriel Teixidó

**EN** · Solid wood frame, 35 Kg. polyether seat and 30 Kg. polyether back. Fix upholstered.

**ES** · Estructura madera maciza, asiento poliéter 35 Kg. y respaldo poliéter 30 Kg. Tapizado fijo.

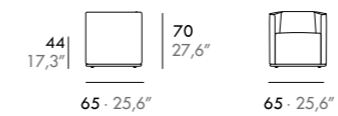





## HEXA · MESA HEXA

TheRobotDesign

**EN** · Beech plywood covered by polyether. Seat and back in 40 Kg/m<sup>3</sup>. polyether (CFC free). Feet in 12mm solid metal rod with plastic sliders. Painted, colour to be chosen by the customer. Fixed upholstery.

**ES** · Contrachapado de haya recubierto de poliéter. Asiento y respaldo de poliéter 40 Kg/m<sup>3</sup>. (sin CFC). Pies de varilla de metal macizo de 12 mm con deslizadores de plástico. Pintado, color a elegir por el cliente. Tapizado fijo.

**EN** · Coffe table . Wood top available in varnished finish, lacquered in any RAL colour or black marble. 12mm metallic calibred rod feet painted in any RAL colour.Optional: metallic rod painted in copper or gold colour with extracharge.

**ES** · Mesa de centro con sobre de madera maciza lacado color carta RAL o sobre mármol negro. Pies en varilla metálica calibrada de 12mm. Pintada color carta RAL. Opcional varilla pintada color cobre o oro, con suplemento.

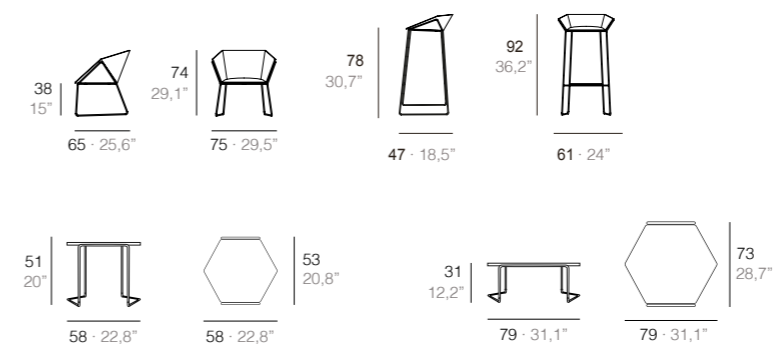

**Sobre lacado**  
Lacquered top

**Sobre Mármol**  
Marble top



## HIRU · HIRUSTA

Gabriel Teixidó

**EN** · Coffee table in solid beechwood varnished in oak, walnut or wengué, or lacquered in white or black.

**ES** · Mesa de centro en madera maciza de haya barnizada en color roble, nogal o wengué, o lacada en blanco o en negro.

Hiru

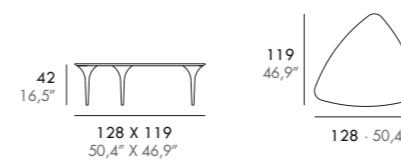

Hirusta

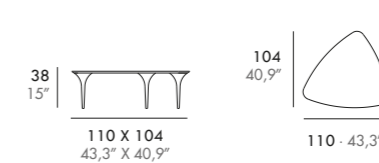

**Roble**  
Oak



**Wengué**  
Wengue



# INBOL

José Gras

**EN** · Solid wood frame, 35 Kg. polyether seat and 30 Kg. polyether back. Fix upholstered.

**ES** · Estructura madera maciza, asiento poliéter 35 Kg. y respaldo poliéter 30 Kg. Tapizado fijo.

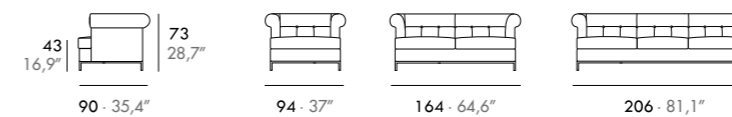







## INTERVAL

José Gras

**EN** · Solid wood frame, 35 Kg. polyether seat and 30 Kg. polyether back. Fix upholstered.

**ES** · Estructura madera maciza, asiento poliéter 35 Kg. y respaldo poliéter 30 Kg. Tapizado fijo.





# INTRUDER

Gabriel Teixidó

**EN** · Metallic frame, suspension by metallic springs comfort to choose: soft, middle or firm. 35 Kg/m<sup>3</sup>. polyether seat, 30 Kg. polyether back. Fix upholstered.

**ES** · Estructura metálica, suspensión mediante muelles confort a elegir: suave, medio y firme. Asiento poliéter 35 Kg/m<sup>3</sup>, respaldo poliéter 30 Kg. Tapizado fijo.

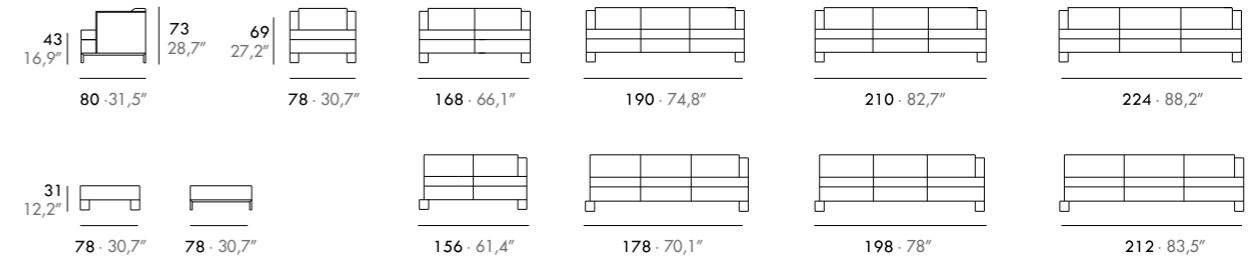



# INVADER

Gabriel Teixidó

**EN** · Metallic frame, suspension by metallic springs comfort to choose: soft, middle or firm. 35 Kg/m<sup>3</sup>. polyether seat, 30 Kg. polyether back. Fix upholstered.

**ES** · Estructura metálica, suspensión mediante muelles confort a elegir: suave, medio y firme. Asiento poliéster 35 Kg/m<sup>3</sup>, respaldo poliéster 30 Kg. Tapizado fijo.

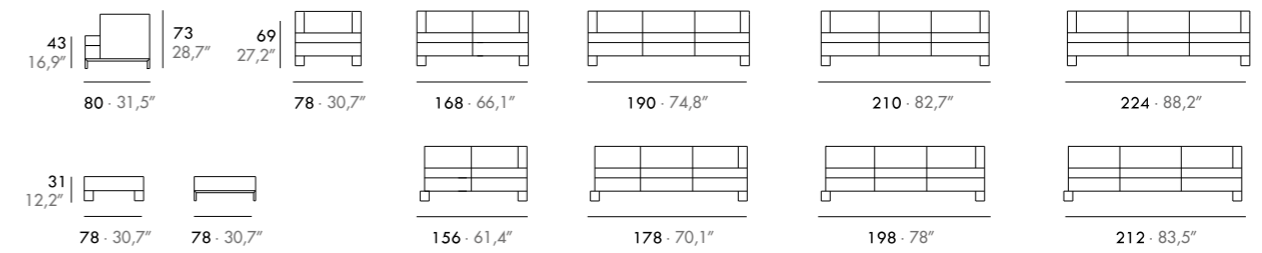



## JACK

José Gras

**EN** · Solid wood frame, 35 Kg. polyether seat and 25 Kg. polyether back. Completely removable covers.

**ES** · Estructura madera maciza, asiento poliéter 35 Kg. y respaldo poliéter 25 Kg. Tapizado totalmente desenfundable.

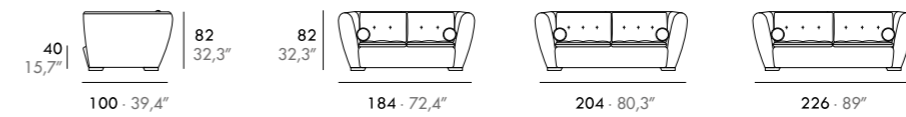





## KANEL · KANEL FLUFFY

Gabriel Teixidó

**EN** • Solid wood covered by polyether. Interlaced elastic webbing. Seat in 35 Kg/m<sup>3</sup> high resilience polyether (CFC free). Back in 30 Kg/m<sup>3</sup> polyether (CFC free). Outside back padded with piping, feet in calibrated rod painted Ral color chart. Optional: Rod painted in cooper color. Fix upholstered.

**ES** • Madera maciza recubierta de poliéter. Cinchas elásticas entrelazadas. Asiento cojín de poliéter de 35 Kg/m<sup>3</sup> (sin cfc). Respaldo cojín de poliéter de 30 Kg/m<sup>3</sup> (sin cfc). Exterior respaldo acolchado y con vivos. Pies varilla calibrada pintada en color carta RAL a juego de la tela o contrastada. Opcional pintura acabado cobre. Tapizado fijo.



Kanel Fluffy



Kanel

## KOLY FIJA · KOLY VEL

Gabriel Teixidó

**EN** · Solid wood frame. 35 Kg/m<sup>3</sup> polyether seat and 30 Kg/m<sup>3</sup> polyether back, adjustable headcushion. Fix upholstery. Removable covers optional (Koly Vel).

**ES** · Estructura madera maciza. Asiento poliéter 35 Kg./m<sup>3</sup> y respaldo poliéter 30 Kg/m<sup>3</sup>, cabezal regulable en altura. Tapizado fijo. Opción desenfundable (Koly Vel).

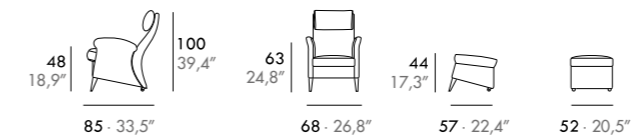

**Koly**  
Fixed upholstery



**Koly Vel**  
Removable cover



## LAVANDA · MENTA · SALVIA

José Gras

**EN** · Side table in natural veneer walnut, oak and wenge or white lacquered. Steel base, painted in white or black.

**ES** · Mesa auxiliar en chapa natural de nogal, roble y wengué, o acabado lacado en blanco. Base metálica de acero laminado, pintada blanca o negra.

Lavanda

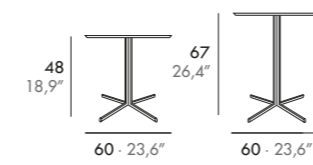

Menta

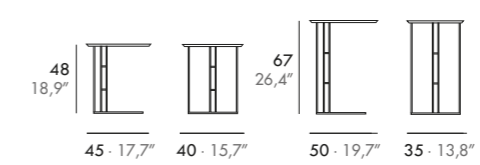

Salvia

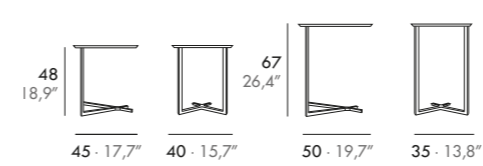

Lavanda



Menta



Salvia









## LOOP

Gabriel Teixidó

**EN** · Pime wood covered by polyether frame, 35 Kg/m<sup>3</sup> polyether covered by hallow fiber seat, metallic frame back made of round pipe + 25 Kg/m<sup>3</sup> polyether covered by hollow fiber 12 mm calibred metallic chromed rod feet. Fixed upholstery.

**ES** · Estructura madera de pino, recubierta de poliéter. Asiento poliéter de 35 kg/m<sup>3</sup>, recubierto de guata. Respaldo estructura metálica de tubo redondo y poliéter de 25 kg/m<sup>3</sup>, recubierto de guata. Pies varilla metálica calibrada de 12mm, cromada. Tapizado fijo.

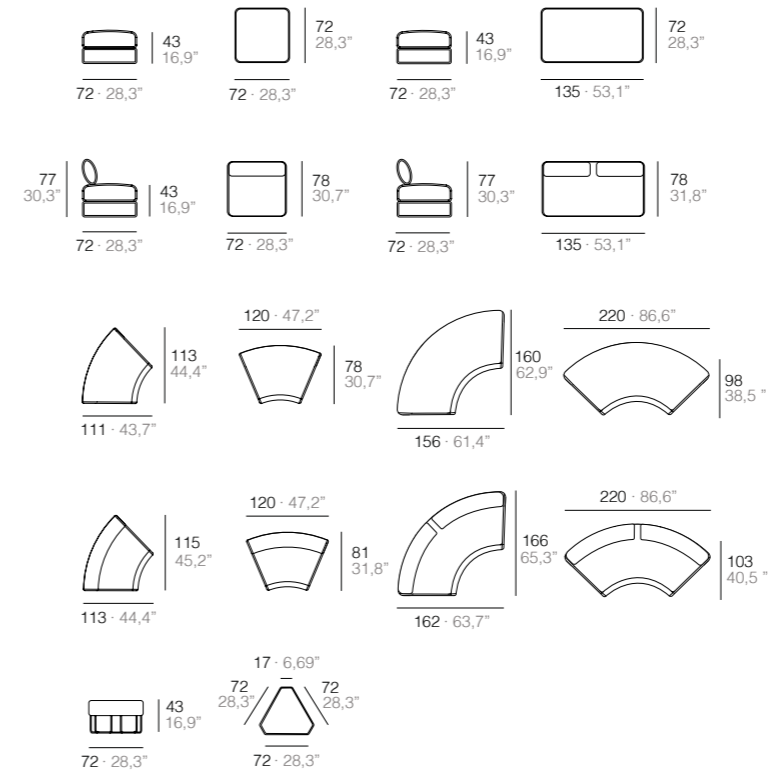



# MADALENA

Gabriel Teixidó

**EN** · Solid wood frame, 35 Kg. polyether seat.

**ES** · Estructura madera maciza, asiento poliéter 35 Kg.

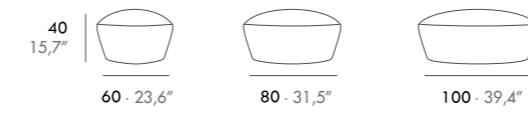





## MAD BUREAU · MAD HOME

TheRobotDesign

**EN** · Frame in 40 mm MDF, in natural walnut veneer. Seat in thermic viscoelastic cushion with 50 Kg. "memory effect" foam+ a 30 Kg/m<sup>3</sup>. soft polyether cushion (cfc free).

**ES** · Estructura en MDF de 40 mm. en chapa natural de nogal americano. Asiento cojín visco térmico de poliéter 50 Kg/m<sup>3</sup> extraconfort "efecto retorno"+ poliéter de 30 Kg/m<sup>3</sup> suave (sin cfc).

### MAD Home

Back cushions in a combination of 60% antiallergic hollow fibre and 40% down feather. Arm cushions in 30 Kg/m<sup>3</sup> polyether cushion (cfc. free), covered by acrylic padding.

### MAD Home

Respaldo combinación de 60% de fibra antialérgica y 40% de pluma de ave acuática. Brazos cojín de poliéter de 30 Kg/m<sup>3</sup> (sin cfc) recubierto de boata acrílica.

### MAD Bureau

Back cushions in 25 Kg/m<sup>3</sup> polyether (cfc free). Arm cushions in 30 Kg/m<sup>3</sup>. + 60 Kg/m<sup>3</sup> polyether (cfc free), covered by acrylic padding. Metallic feet black chrome finish. Fixed upholstery and completely removable cover in the cushions.

### MAD Bureau

Respaldo cojín poliéter de 25 Kg/m<sup>3</sup> con refuerzo de 60 Kg/m<sup>3</sup>. Brazos cojín de poliéter de 30 Kg/m<sup>3</sup> (sin cfc) con refuerzo de 60 Kg/m<sup>3</sup> y recubierto de boata acrílica. Pies con acabado cromo negro. Tapizado fijo y cojines desenfundables.

Mad Bureau

Mad Home

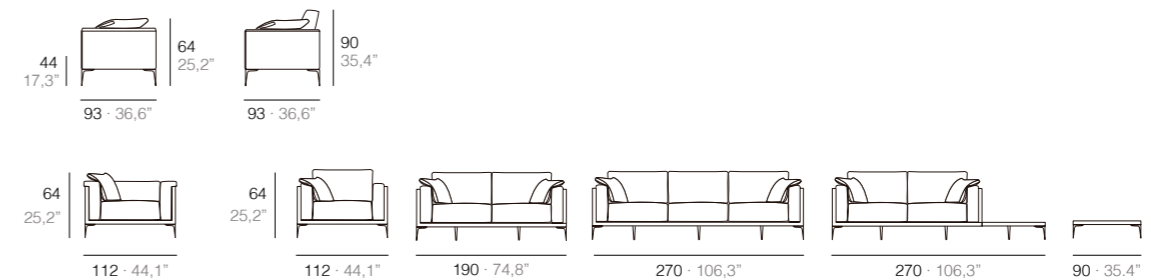

Mad Bureau



Mad Home





# NICOLAY

Grassoler Studio

**EN** • Solid wood frame, covered by polyether. Interlaced elastic webbing suspension. Seat in 100% microfiber with 30 kg /m<sup>3</sup> polyether. Back in 100% microfiber. Beechwood feet varnished in natural. Completely removable cover. We recommend upholstering Nicolay collection in natural fabrics such as linen or cotton. Other types of fabrics are not suitable.

**ES** • Estructura de madera maciza recubierta de poliéter. Cinchas elásticas entrelazadas. Asiento 100% microfibra con inserto de poliéter 30Kg/m<sup>3</sup>. Respaldos 100% microfibra. Pies en madera de haya barnizada en natural. Totalmente desenfundable. Nicolay es ideal para tapizar en telas naturales tipo lino o algodón. No se recomienda otro tipo de telas.

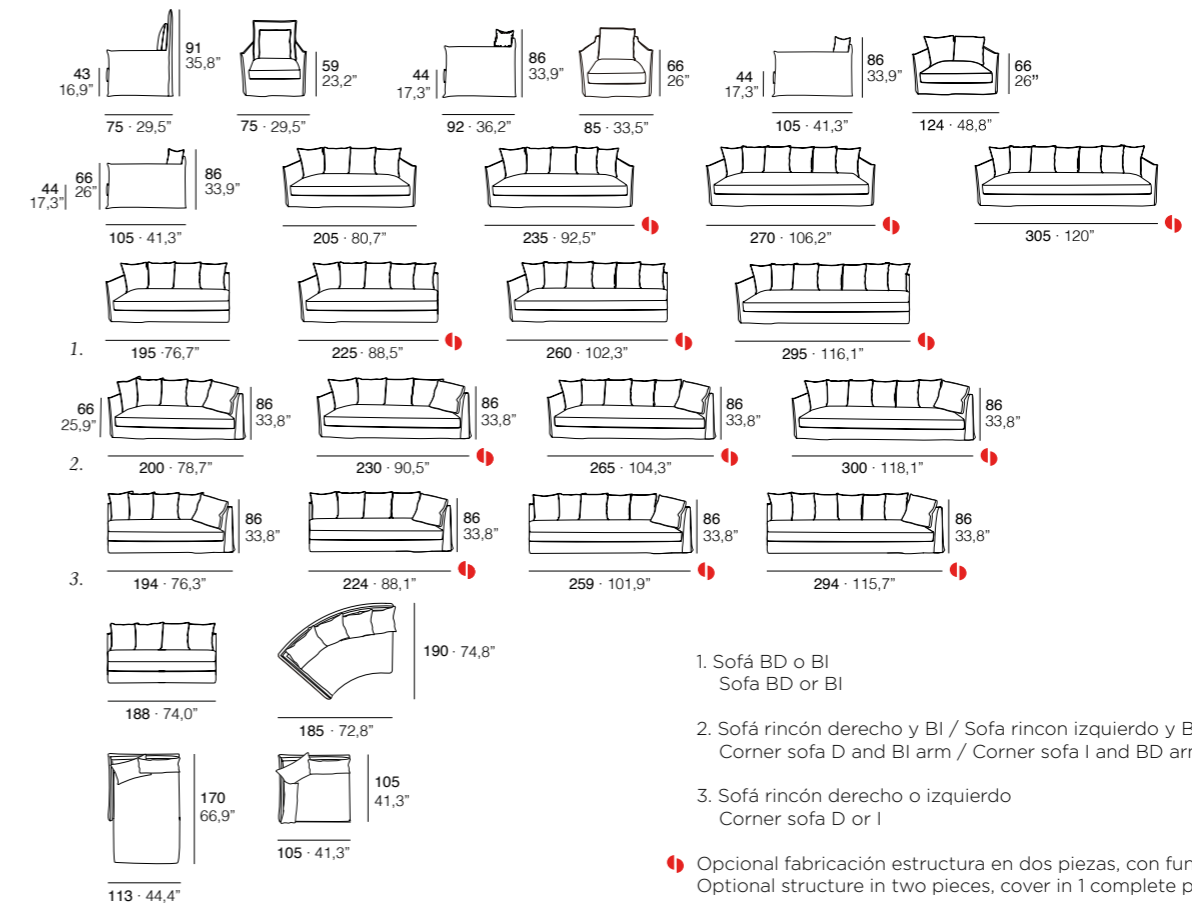







# NICOLAY CALMA

Grassoler Studio

## EN · Nicolay Headboard - Bed base

40 kg/m<sup>3</sup>. Polyether (cfc free) covered by acrylic padding. Completely removable cover.

## Nicolay Box spring bed

Double metal structure bed frame with anticorrosive finish. Reinforcement system with 8 horizontal metal stringers. Natural wood legs. 3D fabric in central area to breath and prevention against germs.

## Bed canopy

Cold rolled iron, epoxy painted, anticorrosive.

## Nicolay Sleeper - Sofa

Solid wood frame, covered by polyether. Antioxidant metal mechanism, with epoxy resin finishing. Mattress base with electric weld metal mesh, attached to the mechanism with springs, and elastic straps under the seat. Removable arms, backrest and front board. Seat in 30 Kg/m<sup>3</sup> polyether, covered in 100% microfiber. Back in 100% microfiber. Arms and cushions with removable cover.

## ES · Nicolay Cabecero de cama

Poliéter de 40 kg/m<sup>3</sup>. (sin cfc) recubierto de gata acrílica. Totalmente desenfundable.

## Nicolay Canapé

Base con doble estructura metálica con acabados anticorrosivos. Sistema de refuerzo con 8 largueros metálicos horizontales. Patas de madera natural. Tejido 3D para máxima transpiración y prevención contra el desarrollo de ácaros.

## Dosel

Acero laminado en frío pintado al epoxy anticorrosivo.

## Nicolay Sofá - Cama

Estructura de madera maciza recubierta de poliéter. Mecanismo metálico, antioxidante y acabado con resina epoxi. Somier metálico de malla electro soldada unido con muelles al mecanismo y cinchas elásticas en el asiento. Los brazos, el frente y el contra son desmontables. Asiento de poliéter de 30Kg/m<sup>3</sup> recubierto con fibra hueca siliconada. Respaldo de fibra hueca siliconada. Brazos y cojines desenfundables.

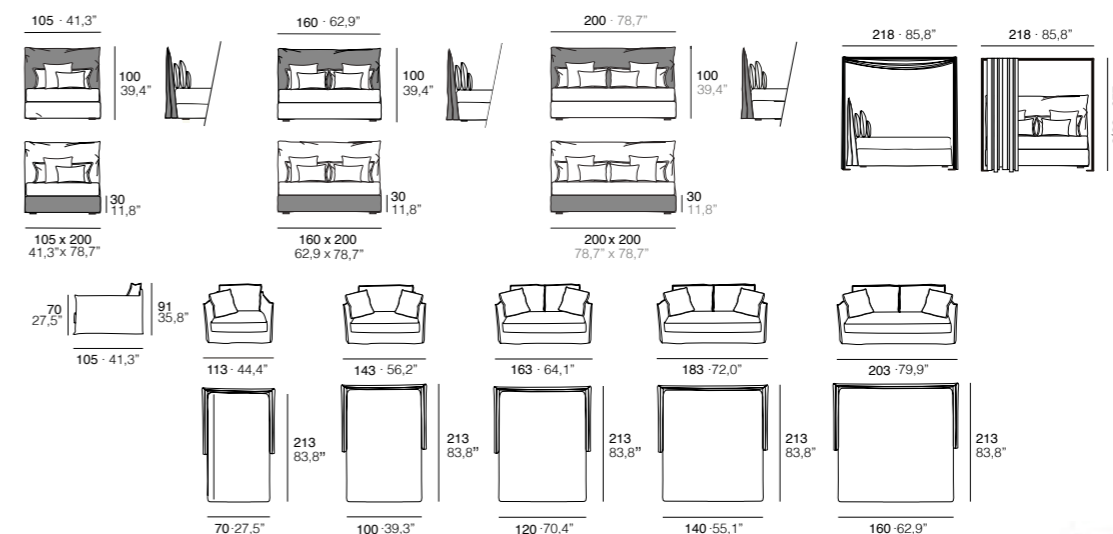

Sofá cama  
Sleeper sofa



Cama  
Bed



## NICOLAY ESENCIAL

Grassoler Studio

### EN · Nicolay Chair - Stool

Solid wood frame, covered by polyether. Seat in 35 kg /m<sup>3</sup> polyether (cfc free). Back in 25 kg /m<sup>3</sup> polyether (cfc free). Beechwood feet varnished in natural and oak 470. Completely removable cover.

### Footstools

**Nicolay Square footstool 83x83** Solid wood frame, covered by polyether. Seat in 100% microfiber with 30 kg /m<sup>3</sup> polyether. Beechwood feet varnished in natural. Completely removable cover.

**Nicolay Rectangular Footstool 50x100** Solid wood frame, covered by polyether. Seat in 35 kg /m<sup>3</sup> polyether (cfc free). Beechwood feet varnished in natural. Completely removable cover.

**Nicolay Round Footstool** Solid wood frame, covered by polyether. Seat in 35 kg /m<sup>3</sup> polyether (cfc free). Beechwood feet varnished in natural. Completely removable cover.

### ES · Nicolay Silla - Taburete

Estructura de madera maciza recubierta de poliéter. Asiento en 35 kg /m<sup>3</sup> poliéter (sin cfc. respaldo en 25 kg /m<sup>3</sup> poliéter (sin cfc). Pies en madera de haya barnizada en natural o Roble 470. Totalmente desenfundable.

### Banquetas

**Nicolay Banqueta Cuadrada 83x83** Estructura de maderamaciza recubierta de poliéter. Asiento 100% microfibra con inserto de poliéter 30Kg/m<sup>3</sup>. Pies en madera de haya barnizada en natural. Totalmente desenfundable.

**Nicolay Banqueta Rectangular 50x100** Estructura de madera maciza recubierta de poliéter. Asiento en 35 kg /m<sup>3</sup> poliéter (sin cfc.), Totalmente desenfundable. Pies en madera de haya barnizada en natural. Totalmente desenfundable.

**Nicolay Banqueta Redonda** Estructura de madera maciza recubierta de poliéter. Asiento en 35 kg /m<sup>3</sup> poliéter (sin cfc.), Totalmente desenfundable.

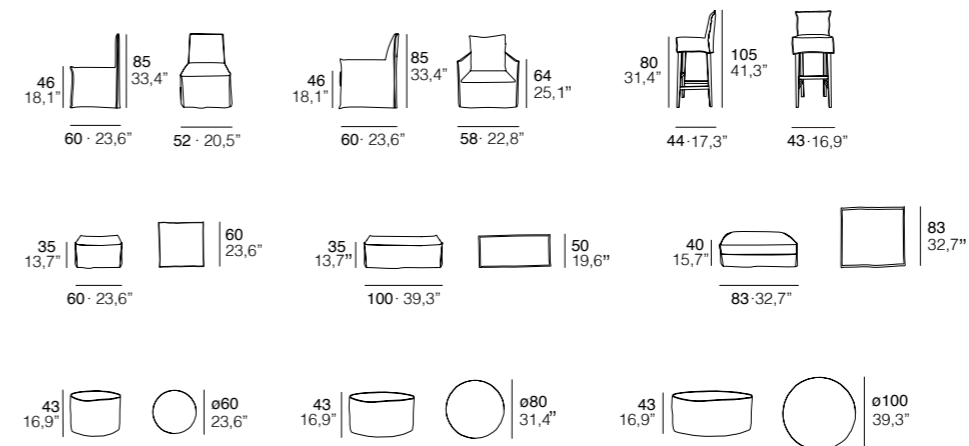



Et j'ai acheté des hochets  
Pour toi mon amour,  
Je suis allé au marché à la ferraille  
Et j'ai acheté des chaînes  
De lourdes chaînes



# ODIN FUN

José Gras

**EN** · In Anti-corrosion painted metal frame. Suspension with NEA elastic webbing. Seat in VISCOELASTIC cushion memory foam effect 55 Kg, base 35 Kg, back in 100% antiallergic microfiber. Cushions 40x40cm in 100% hollow fiber. Arms in 100% antiallergic hollow fiber. Feet available in Black metallic feet. Height 18 cm. Completely removable Cover. Zippers available in BEIG, GREY or BLACK.

**ES** · Estructura metálica pintada anticorrosión. Suspensión mediante cinchas Nea. Asiento Viscoelástico extranconfort "efecto retorno" de 55 kg y base de 35 kg (sin cfc). Respaldo de microfibra antialérgica. Cojines de 40x40 cm. 100% de fibra. Pies metálicos pintados negro mate. Tapizado de la estructura fijo y cojines desenfundables. Cremalleras decorativas disponibles en colores BEIGE, GRIS o NEGRO.

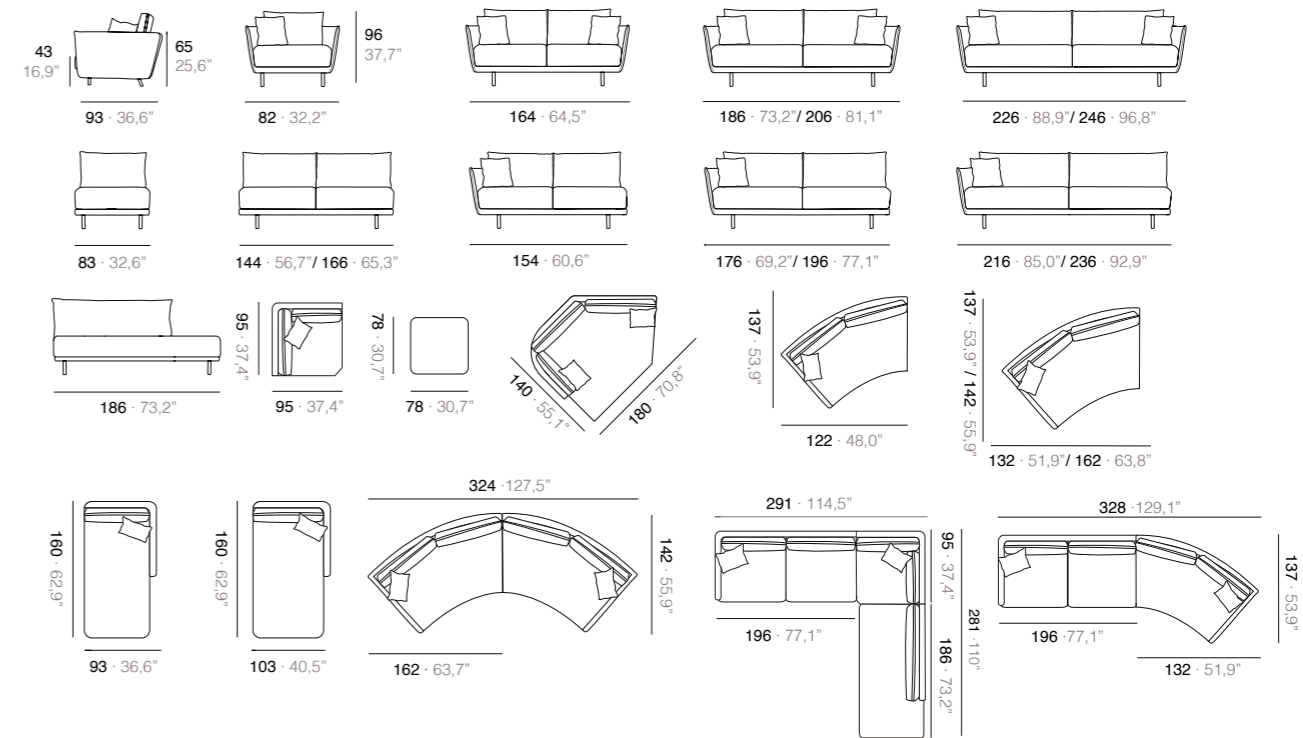



Stuff your eyes with  
**WONDER**  
LIVE AS IF YOU'D  
**DROP DEAD**  
IN TEN SECONDS  
See the world.  
IT'S MORE FANTASTIC THAN ANY  
**DREAM**  
PHOTOGRAPHS

IT'S MORE EA



## ODYSSEY FUN

José Gras

**EN** · Metallic frame. Suspension by Nea elastic webbings. Seat in 35 Kg/m<sup>3</sup> and 23 Kg/m<sup>3</sup> polyether. Back with a combination of fiber/down feather, cushions in antiallergic fibre. Fixed upholstery. Completely removable covers.

**ES** · Estructura metálica. Suspensión mediante cinchas Nea. Asiento en poliéter de 35Kg/m<sup>3</sup> y 23 Kg/m<sup>3</sup>. Respaldo en combinación de fibra y pluma, cojines sobrecorredores en microfibra antialérgica. Totalmente desenfundable.

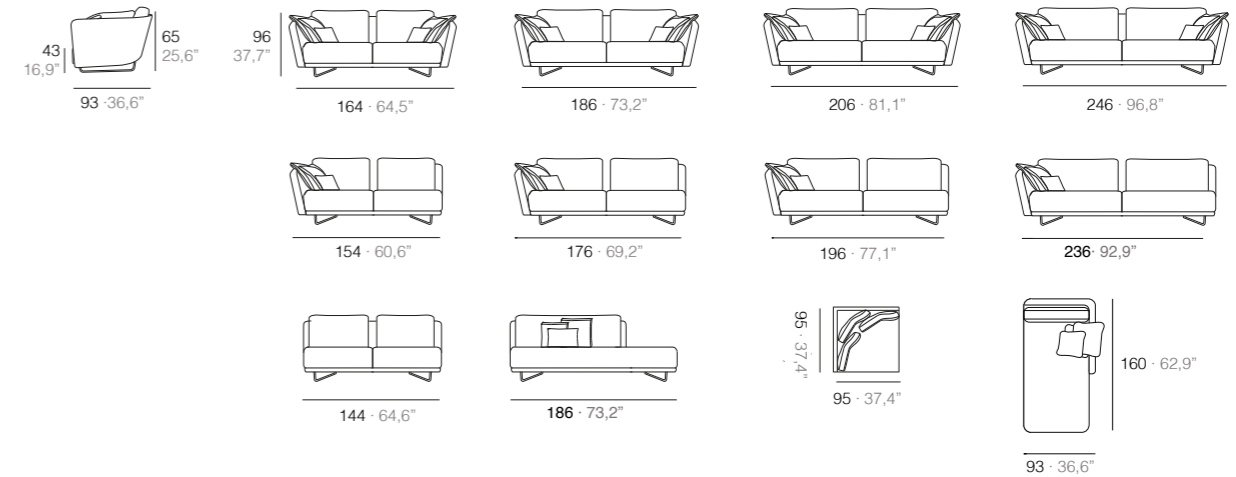

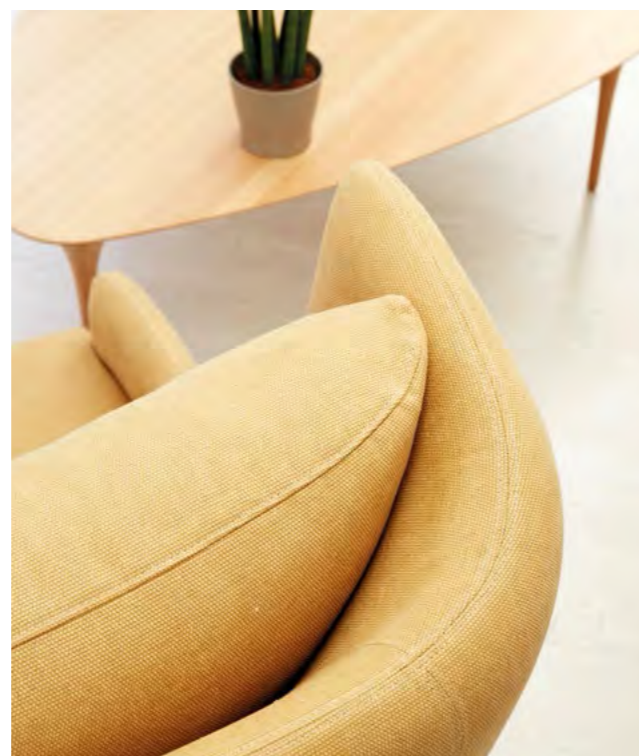

## ONIX

Gabriel Teixidó

**EN** • Metallic frame, suspension by Nosag springs, seat in 35 Kg/m<sup>3</sup> polyether, back and kidney cushion with a combination of fiber/down feather. Completely removable covers.

**ES** • Estructura metálica, suspensión mediante muelles Nosag, asiento en poliéter de 35 Kg/m<sup>3</sup>, respaldo y riñoneras en combinación de fibra y pluma. Totalmente desenfundable.

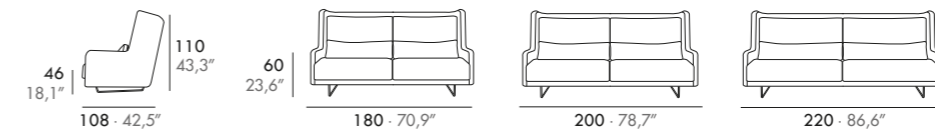

**Pie de madera**  
Wooden Feet



**Varilla cromada**  
Chromed feet



## OPAL

Gabriel Teixidó

**EN** • Solid wood frame, 35 Kg. polyether seat and 25 Kg. polyether back, kidney cushion in fiber. Fix upholstered.

**ES** • Estructura madera maciza, asiento poliéter 35 Kg., respaldo poliéter 25 Kg, riñonera en fibra. Tapizado fijo.

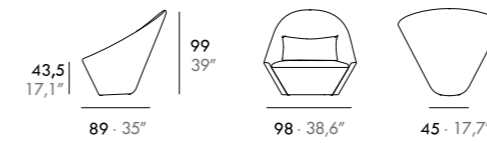







## OPALINA

Gabriel Teixidó

**EN** · Solid wood frame. 35 Kg/m<sup>3</sup> polyether seat and 25 Kg/m<sup>3</sup> polyether back. Fix upholstery.

**ES** · Estructura madera maciza, asiento poliéter 35 Kg/m<sup>3</sup>. Respaldo poliéter 25 Kg/m<sup>3</sup>. Tapizado fijo.

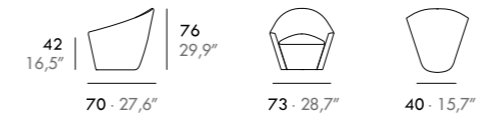



## OPEN AIR

Gabriel Teixidó

**EN** · Solid wood frame, 35 Kg. polyether seat and 35 Kg. polyether back. Fix upholstered.

**ES** · Estructura madera maciza, asiento poliéter 35 Kg. y respaldo poliéter 35 Kg. Tapizado fijo.

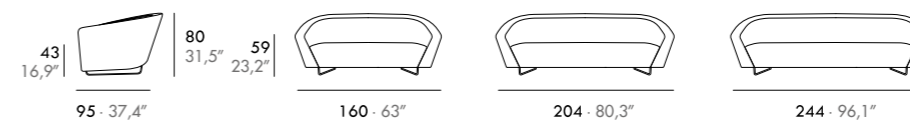



## OPEN AIR VINTAGE

Grassoler Studio

**EN** · Solid wood frame covered by polyether. Interlaced elastic webbing suspension. 35 Kg polyether seat, 35 Kg polyether back. Beechwood feet varnished Wenge 492. Optional: Beechwood varnished in Natural 401, Oak 426 or Walnut G01. Fixed upholstery.

**ES** · Estructura madera maciza recubierta de poliéter. Suspensión cinchas elásticas entrelazadas. Asiento poliéter de 35 Kg. Respaldo poliéter de 35 Kg. Con botones en el respaldo Pies base de madera de haya barnizada color Wengué 492. Opcional base/pies disponibles en haya barnizado Natural 401, Nogal G01 o Roble 426, con suplemento. Tapizado fijo.

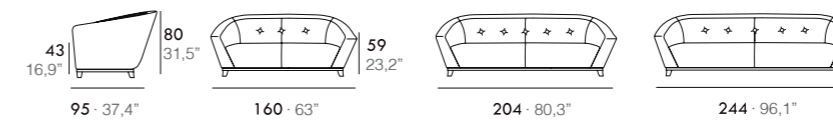



## ORACLE

Gabriel Teixidó

**EN** · Metallic frame, suspension by NEA elastic webbings. Seat in "Viscoelastic" extracomfort 55 Kg / m<sup>3</sup> polyether, back, arm and kidney cushions in down feather. Completely removable covers.

**ES** · Estructura metálica, suspensión mediante cinchas NEA. Asiento viscoelástico 55Kg/m<sup>3</sup> extraconfort, respaldo, brazo y riñoneras de pluma. Totalmente desenfundable.

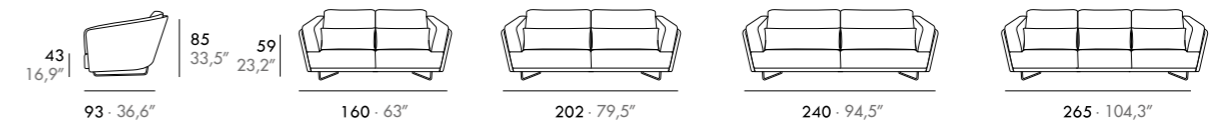

**Varilla cromada**  
Chromed feet



**Pie de madera**  
Wooden Feet



## OXYGEN

Gabriel Teixidó

**EN** · Metallic frame, suspension by NEA elastic webbings. Seat in "Viscoelastic" extracomfort 55 Kg/m<sup>3</sup> polyether, back in down feather and arm cushions in 30 Kg. polyether. Completely removable covers.

**ES** · Estructura metálica, suspensión mediante cinchas NEA. Asiento viscoelástico 55Kg/m<sup>3</sup> extraconfort, respaldo de pluma y brazos de poliéter 30 Kg. Totalmente desenfundable.

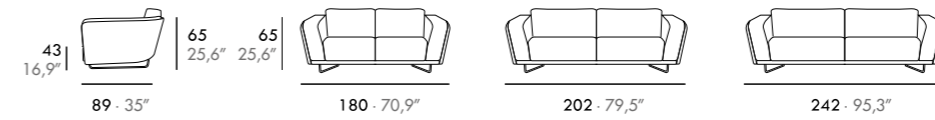

**Varilla cromada**  
Chromed feet



**Pie de madera**  
Wooden Feet



## PARADE

Gabriel Teixidó

**EN** • Solid wood frame. 35 Kg/m<sup>3</sup> polyether seat and 34 Kg/m<sup>3</sup> + 18 Kg/m<sup>3</sup> polyether back. Beechwood feet varnished in wengue. Option: Beechwood feet with chromed metallic covering. Fix upholstery.

**ES** • Estructura madera maciza. Asiento poliéter 35 Kg/m<sup>3</sup>, respaldo poliéter 34 Kg/m<sup>3</sup>. + 18 kg/m<sup>3</sup>. Pies en madera de haya varnizada en color wengué. Opcion: Pies en madera de haya cubierto de chapa metálica cromada. Tapizado fijo.





## PARCEL

Gabriel Teixidó

**EN** · Solid wood frame. 35 Kg/m<sup>3</sup> polyether seat and 34 Kg/m<sup>3</sup> + 18 Kg/m<sup>3</sup> polyether back. Beechwood feet varnished in wengue. Option: Beechwood feet with chromed metallic covering. Fix upholstery.

**ES** · Estructura madera maciza. Asiento poliéter 35 Kg/m<sup>3</sup>, respaldo poliéter 34 Kg/m<sup>3</sup>. + 18 kg/m<sup>3</sup>. Pies en madera de haya varnizada en color wengué. Opcion: Pies en madera de haya cubierto de chapa metálica cromada. Tapizado fijo.







## PASARELA

Gabriel Teixidó

**EN** · Metallic frame anticorrosion painted, 35 kg/m<sup>3</sup> polyester seat cushion. Steel base, painted, or chromed. Fix upholstery.

**ES** · Estructura metálica pintada anticorrosión. Asiento en poliéster de 35 Kg/m<sup>3</sup> con guata. Base metálica pintada o cromada. Tapizado fijo.

**Pasarela alta**  
High Pasarela

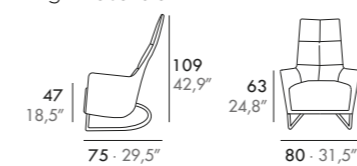

**Pasarela baja**  
low Pasarela

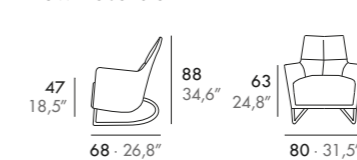

**Pasarela alta**  
High Pasarela

**Pasarela baja**  
Low Pasarela



## PATEK

Gabriel Teixidó

**EN** · Frame solid wood covered with polyether. Removable seat by a knob located on the lower part. Suspension interlaced elastic webbing. Seat 35 Kg Polyether. Back 24 Kg Polyether. Headrest made of acrylic hollow fiber. Adjustable in height. Feet beechwood varnished in Wenge 492 color.

Bench solid wood structure with 35Kg polyether seat. Upholstery fully removable for easy covering and washing in washing machines, only for allowed fabrics. Fixed leather upholstery.

**ES** · Estructura madera maciza recubierta de poliéter. Asiento desmontable mediante pomo situado en la parte inferior para el desenfundado. Suspensión mediante cinchas elásticas entrelazadas. Asiento de poliéter de 35 Kg y respaldo en poliéter de 24 Kg. Cabezal de guata acrílica. Regulable en altura. Pies en madera de haya barnizada en color Wengué 492.

Banqueta Estructura de madera maciza con asiento de poliéter de 35Kg. Tapizado totalmente desenfundable para el fácil enfundado y su lavado en la lavadora en las telas que lo permitan. Cuando se tapiza en piel va tapizado fijo.

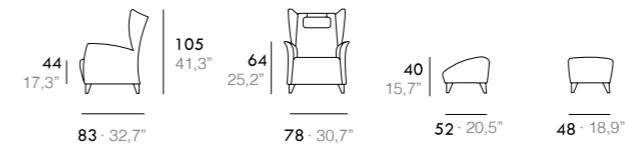

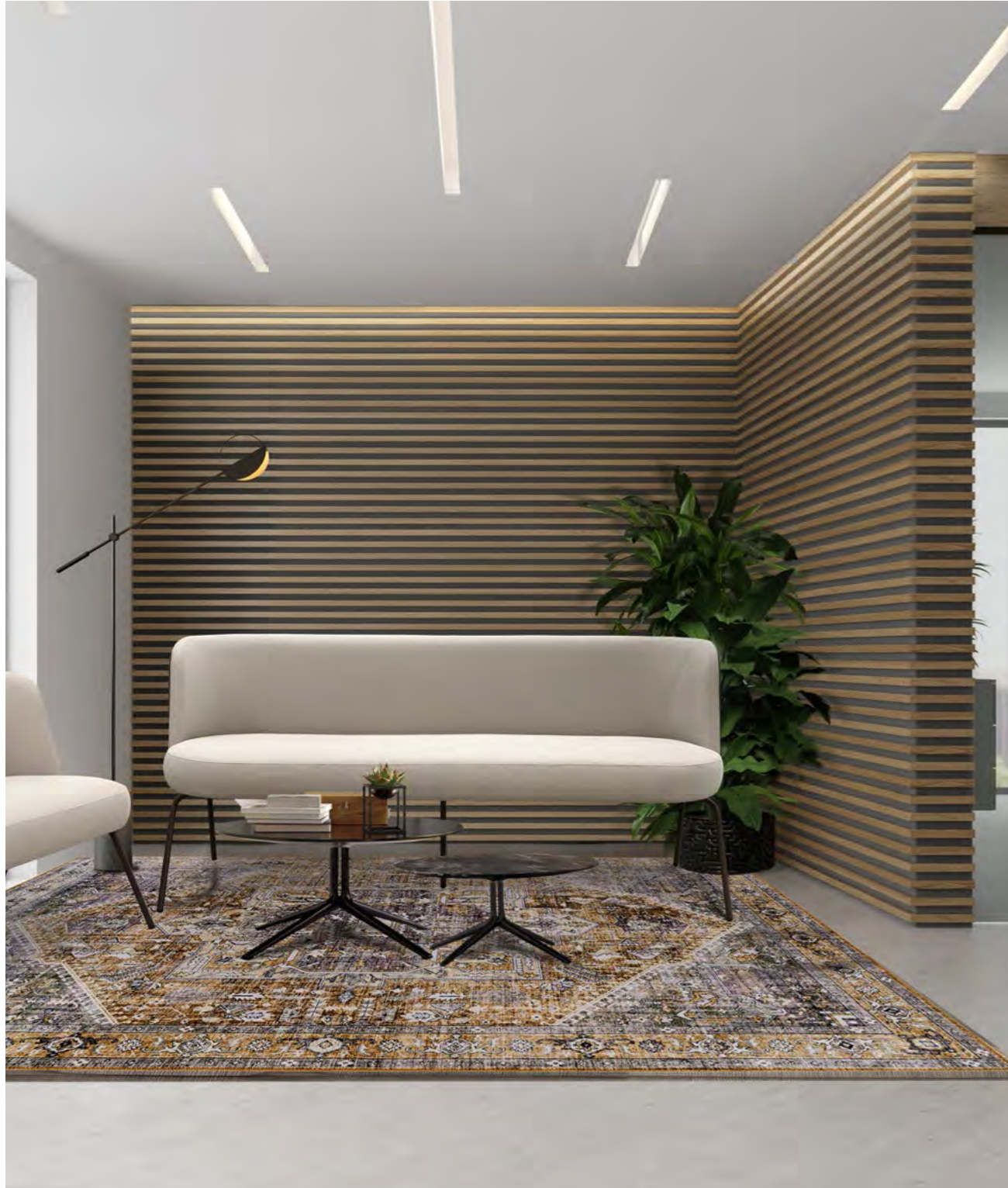

## PIPA

Roger Vancells

**EN** · Solid wood covered by polyether frame, polyether seat covered by hollow fiber, 35 Kg polyether back covered by hollow fiber. 20 mm diameter metal rod feet, RAL color to be selected. Fixed Upholstery.

**ES** · Estructura de madera maciza de pino recubierta de poliéter. Asiento y respaldo de poliéter de 35 Kg, recubierto de boata. Pies varilla calibrada de 20mm pintada color carta RAL. Tapizado fijo.

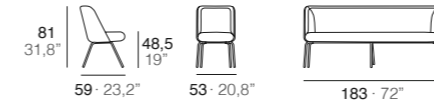





# RIVERSO

Grassoler Studio

**EN** · Cold moulded foam module over metallic frame. Option: feet in solid beechwood varnished. Swivel metallic base. Fix upholstery.

**ES** · Espuma de poliuretano moldeado en frío sobre estructura de acero. Opción: Pies en madera maciza de haya barnizada. Base metálica giratoria. Tapizado fijo.



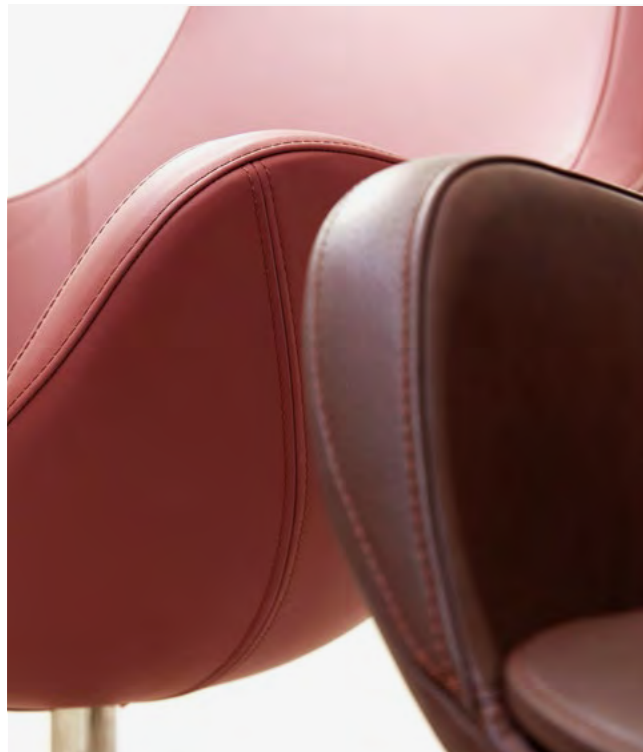
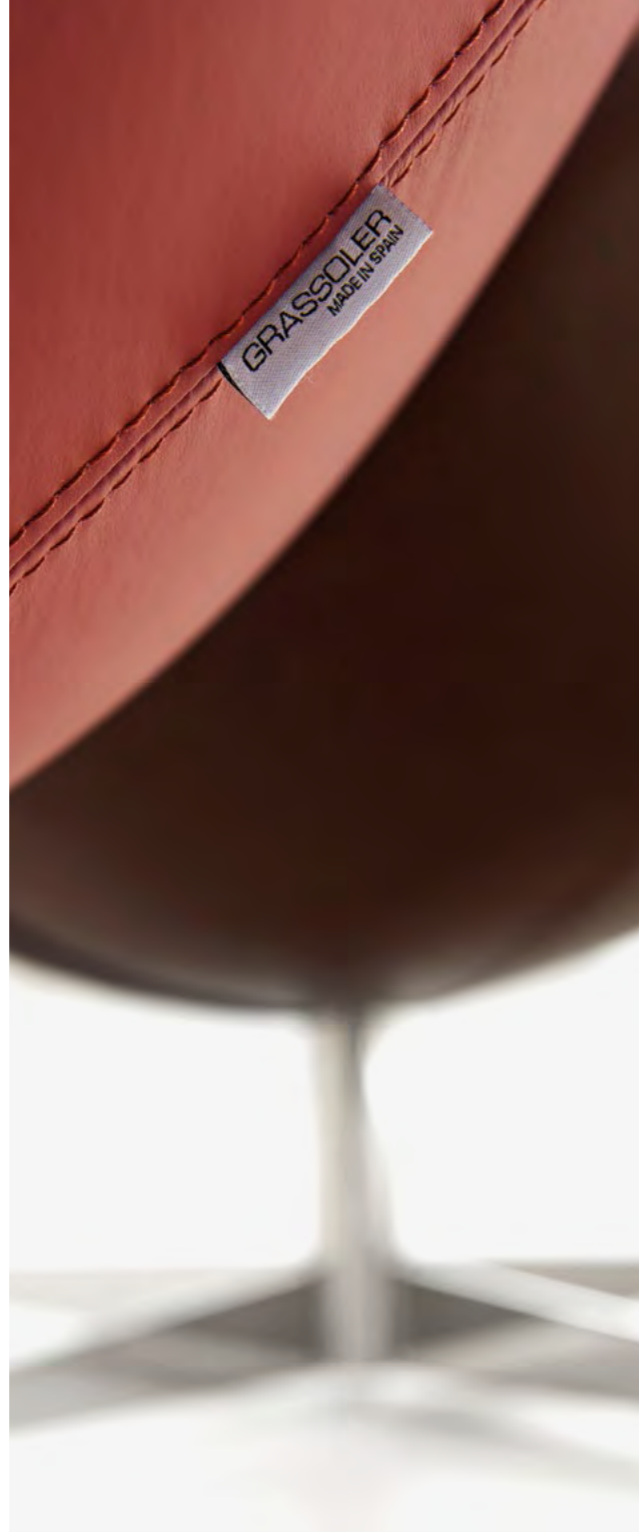



## ROSETTA

Grassoler Studio

**EN** · Cold moulded foam module over metallic frame. Swivel base. Fix upholstery.

**ES** · Espuma de poliuretano moldeado en frío sobre estructura de acero. Base giratoria. Tapizado fijo.

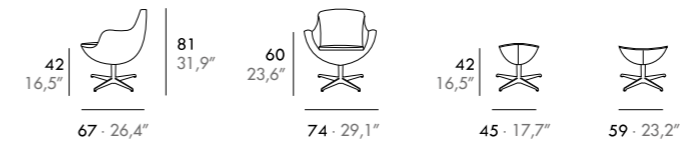



## SENECA

Grassoler Studio

**EN** • Frame pine wood and particle panel covered with HR polyether different densities. Seat removable cushion 30 Kg/m<sup>3</sup> HR soft polyether. Back removable cushion in hollow siliconized polyether fiber. Mechanism metallic, antioxidant and finished with epoxy resin. Bed base metal mesh joined by springs to the mechanism and elastic straps in the seat area. Mattress foam. Detachable components: arms, rear and front.

**ES** • Estructura madera de pino y tablero de partículas recubierto de poliéter HR de varias densidades. Asiento cojín desenfundable de poliéter HR de 30 Kg/m<sup>3</sup> suave, recubierta de fibra de poliéter termoligada. Respaldo cojín desenfundable de fibra de poliéter hueca siliconada. Mecanismo metálico, antioxidante y acabado con resina epoxi. Somier metálico de malla electro-soldada unido con muelles al mecanismo y cinchas elásticas en la zona del asiento. Colchón de espuma. Componentes desmontables: brazos, trasera y frente

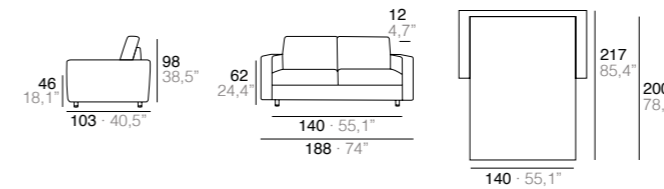







## TONG

Gabriel Teixidó

**EN** • Structure in solid wood frame covered with polyether. Seat and back in polyether. Feet with swivel metal base, available in Chrome or black finish. Fixed upholstery

**ES** • Estructura de madera maciza recubierta de poliéter. Asiento y respaldo en poliéter. Pies en base metálica giratoria. Acabados cromado o negro. Tapizado fijo.

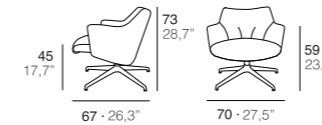

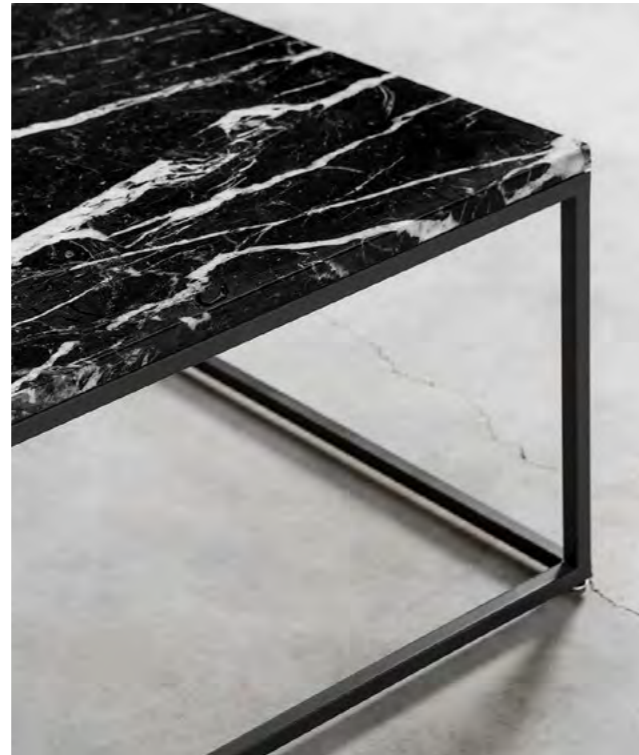

# TOPIC

Victoria Alegri

**EN** · Structure: Polished steel tube with a liquid lacquer, epoxy or polished chrome finish. Top: MDF board with natural veneer finish or special melamine MDF board for lacquer. Natural marble: Carrara white, Marquina black and Oasis green, polished edges. Polished / gloss finish.

**ES** · Estructura: Tubo de acero pulido acabado pintura líquida laca, epoxy o cromo pulido. Sobre: Tablero MDF acabado chapa natural o tablero MDF melamínico especial para laca. Mármoles naturales: Blanco Carrara, negro Marquina y verde Oasis, aristas matadas canto pulido. Acabado pulido / brillo..

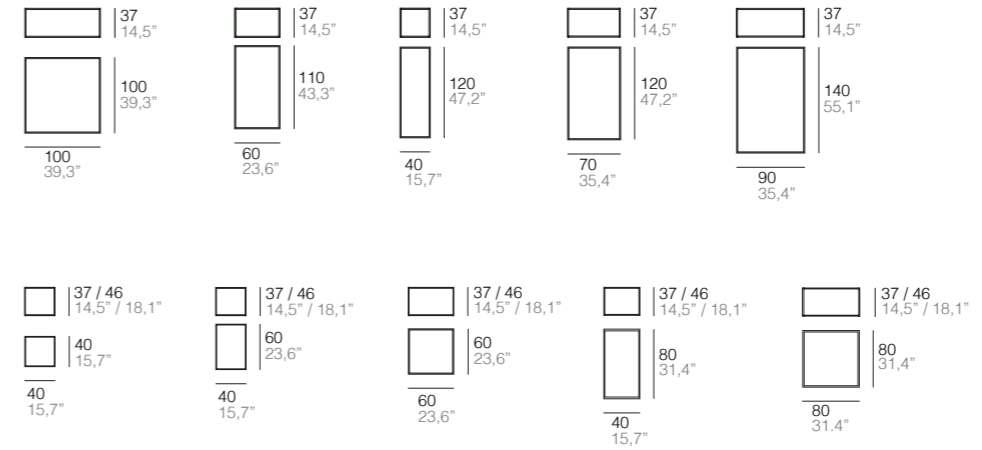



**2 posiciones de asiento**  
2 seat positions



**3 alturas de respaldo**  
3 Back rest heights





## TRAFFIC · TRANSIT

José Gras

**EN** · Metallic frame, knock down structure, suspension by metallic springs, comfort to choose: soft, middle or firm. Two seat inclinations. Seat 35 kgs/m<sup>3</sup> polyether extra comfort on base + 30 Kg/m<sup>3</sup> soft polieter on top, back in 25 Kg/m<sup>3</sup> polyether, kidney cushions in down antiallergic hollow fiber mix. Completely removable covers.

**ES** · Estructura metálica totalmente desmontable. Suspensión mediante muelles, confort a elegir: suave, medio y firme. Dos inclinaciones de asiento. Asiento base de poliéter 35Kg/m<sup>3</sup> extraconfort + poliéter de 30Kg/m<sup>3</sup> suave en la parte superior, respaldo poliéter de 25 kg, elevable 8 cm. mediante un cojín elevador oculto. Con controlador de arrugas. Riñoneras Mezcla de fibras antialérgicas. Totalmente desenfundable.

### Traffic

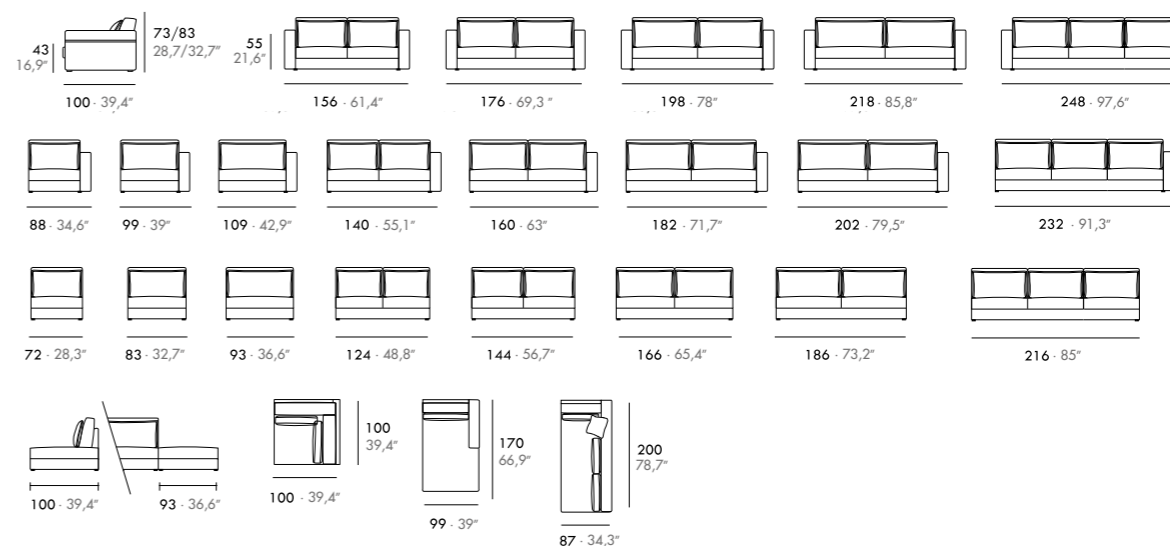

### Transit

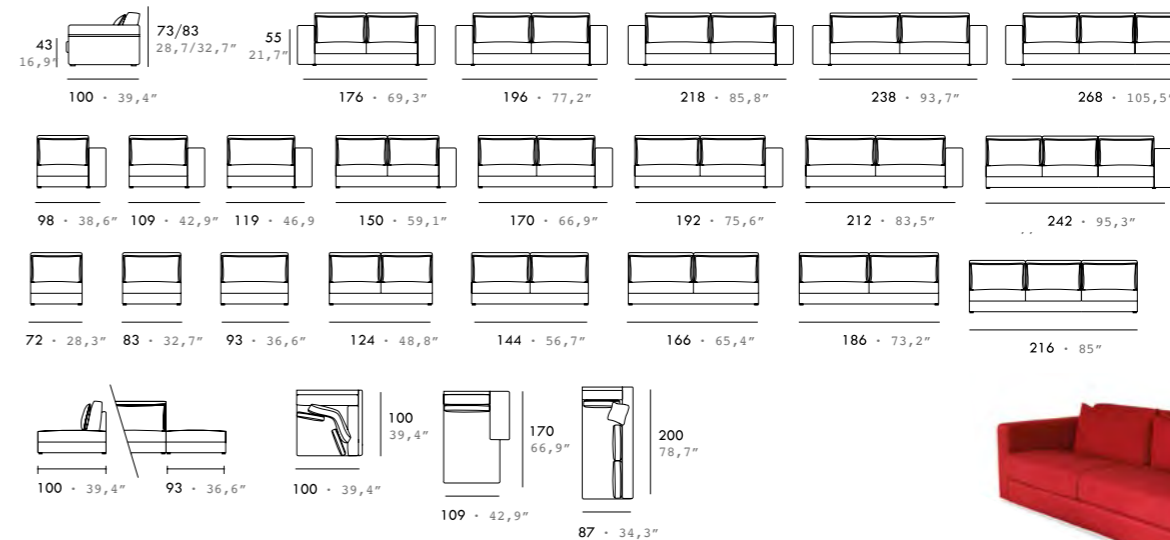



## WASABI

Grassoler Studio

**EN** · Coffee table in solid wood frame, varnished in oak or natural, or lacquered in white or black.

**ES** · Mesa de centro en madera maciza barnizada en color roble, o natural o lacado en blanco o negro.

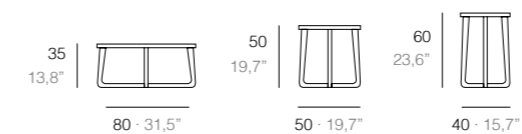



“The magic of our models lies in the passion of our work, because it comes from the heart. The best reward is all the stories behind these 63 years...”

“La magia de nuestras piezas reside en hacer las cosas con pasión, desde el corazón. La mejor recompensa son las historias que hay detrás de estos 63 años...”

Joaquim Domingo  
Patricia Gras





GS

CONTRACT  
BOOK